

Active for more comfort: Passive House

Information for property developers, contractors and clients

International

PASSIVE HOUSE

Association



Company information

Second edition 2014
available online at
www.passivehouse-international.org
Print run: 5,000

Publisher

International Passive House Association
Rheinstraße 44 | 46
64283 Darmstadt | Germany
Tel.: +49 (0) 6151 82699-33
Fax: +49 (0) 6151 82699-34
info@passivehouse-international.org
www.passivehouse-international.org

Copyright

Passive House Institute (PHI)
www.passivehouse.com

Production and advertising | compilation of project reports

Passivhaus Dienstleistung GmbH (PHD)
Rheinstraße 44 | 46
64283 Darmstadt | Germany
Tel.: +49 (0) 6151 36033-0
Fax: +49 (0) 6151 36033-11
post@passivhaus-info.de
www.passivhaus-info.de

Graphic design and layout

Marlies Blücher | Passive House Institute

Editorial head

Sarah Mekjian | Passive House Institute

Printing press

Schmidt printmedien GmbH

Graphic and photo credits

Alexandra Lechner (cover photo, pp. 9, 38), Michael Nau (sketch p. 6), Leigh Simpson (pp. 7, 28), Tania Diego Crespo (p. 14), FAAG Technik GmbH, Jochen Müller (p. 15), Bettina Glaser (pp. 19, 24, 29), Michael Tribus Architecture (p. 27), Meravis Wohnungsbau- und Immobilien GmbH (p. 30), Karolina Glodowska (sketch p. 31), Octavia Housing (p. 32), Sam MaCafee (thermal image p. 33), Hervé Abbadie (p. 41), Ty Cole Photography (p. 45), Zsolt Batár (p. 46), Francesca Gregori (p. 47); unless otherwise indicated, all other photos and graphics, Passivhaus Dienstleistung & Passive House Institute

We are grateful to all architects, designers, property developers, and others who submitted their Passive House buildings for the 2014 Passive House Award and supported us in the preparation of this brochure.

Disclaimer

The descriptions of and technical data on Passive House projects documented in this brochure are based on the information provided by the respective designers. Verification of this information was not possible in every case. Certified Passive House Buildings are identified as such. The Author cannot be held liable for possible damages that might result from the use of the offered information. The contents of this work are protected by copyright; all rights reserved.

ACTIVE FOR MORE COMFORT: PASSIVE HOUSE

Foreword

Passive House has established itself as the internationally acknowledged standard for energy efficient architecture. Its potential has not only been recognised in Germany, where it was originally developed; thousands of Passive House buildings have been built throughout Europe, with an increasing number worldwide in places ranging from North America to the Far East. The reason for this success is simple: the Passive House Standard is clearly defined and it works for all building types in all climate zones. At the same time, it provides a solution for the sustainable use of natural resources. Research has shown the energy consumption for heating and cooling in Passive House buildings to be roughly 80 percent lower than in conventional buildings.

Passive House offers a realistic option for cost-effective structures that provide high levels of comfort while using very little energy for heating and cooling. In the face of rapidly increasing energy prices, this makes Passive House an economically attractive option. For homeowners and residents, it is also a chance to gain independence from volatile energy markets. The energy needs of a Passive House building are so low, that they can easily be met with active solar gains or other renewable sources located either onsite or nearby.

While most Passive House buildings constructed thus far have been residential new builds, an increasing number of people are becoming aware of the advantages the Passive House Standard offers for other building types as well. There are many excellent examples of Passive House offices, schools, kindergartens, gyms, supermarkets, hotels, and even indoor swimming pools.

Whether for use in a hospital or in a single family home, the Passive House components that have proven to be effective in new builds also increase energy efficiency significantly when used in retrofits. This will prove vital for construction companies and building owners alike: in many parts of the world, retrofitting of the building stock is the main growth sector within the construction industry.

This brochure provides an overview of what the Passive House Standard is all about – especially for those planning to embark on their own building project. More information can be found on the website of the International Passive House Association (iPHA) and on Passipedia, the online Passive House resource. Those wishing to experience Passive House first-hand may visit buildings each November during the International Passive House Days, an event for which the doors of several hundred Passive Houses worldwide are opened to the public. During this event, residents can provide answers to curious visitors that often prove far more convincing than hard scientific data. For experts, on the other hand, the International Passive House Conference is held every spring.

I very much hope you enjoy reading this brochure – whether you're searching for general information on the topic or already have a Passive House project in mind.

Yours sincerely,

Dr. Wolfgang Feist

Founder and Director, Passive House Institute
and International Passive House Association

Professor, Department of Energy Efficient Construction
and Building Physics, University of Innsbruck, Austria

www.passivehouse-international.org

CONTENTS

PAGE

01

BASIC INFORMATION

- 04 Passive House – doing more with less
- 10 An international standard
- 14 A prudent investment
- 16 Expertise you can trust

02

DETAILED INFORMATION

- 20 Thermal bridge free and airtight
- 22 Passive House windows
- 24 Superior ventilation
- 26 Passive House – not just for houses
- 31 Local authorities take action
- 32 Retrofit for the future
- 40 Efficiency – the key to green building
- 44 Maximum benefit, minimal cost
- 46 Quality is fundamental
- 47 Easy comfort

03

PROJECT REPORTS – the 2014 Passive House Award winners

- 50 The 2014 Passive House Award
- 52 Project reports – award winners



01

BASIC INFORMATION

04 Passive House – doing more with less

10 An international standard

14 A prudent investment

16 Expertise you can trust



Passive House – doing more with less

In a league of its own

Passive House buildings combine unparalleled comfort with very low energy consumption. Quality design and craftsmanship paired with superior windows, high levels of insulation and heat recovery ventilation are the key elements that set Passive House construction apart. In terms of appearance, however, these extremely efficient buildings blend in perfectly with their conventional neighbours. This is because Passive House describes a performance standard and not a specific construction method: while Passive House buildings must meet specific energy demand targets, building designers are free to choose how best to meet them.

What is so special about Passive House?

1. Exceptionally high levels of insulation
2. Well-insulated window frames and glazings
3. Thermal bridge free design and construction
4. An airtight building envelope
5. Ventilation with highly efficient heat or energy recovery

More comfort, less energy

With Passive House, careful planning and execution is essential. This attention to detail ensures a minimal energy demand: 10 tea lights or even the body heat of 4 people could keep a 20 m² Passive House room warm in the middle of winter, even in extremely cold climates. In reality of course, Passive Houses are not heated with tea lights; they use efficient heating systems and draw on the ventilation that is in any case needed to ensure high indoor air quality. Passive House buildings provide impressive levels of comfort in the summer as well, making air conditioning needs obsolete in most climates and very low in more extreme situations. Simply put, Passive Houses keep the total energy needed for heating and cooling extremely low.

Adapted to the local climate

The Passive House Standard can be implemented all over the world and the general approach is always the same. Depending on the local climate, the properties of individual components will vary. In hotter climates, for example, special attention should be paid to passive cooling measures, such as shading and window ventilation, to ensure comfort during the hot months. The individual characteristics of any Passive House should be optimised to the local conditions.

“With Passive House, building heat losses are reduced so much that hardly any heating is needed at all. The sun, the occupants, household appliances, and even the heat recovered from used air cover a large part of the heating demand. The remainder can then often be provided by the ventilation system.” | Wolfgang Feist, Founder and Director of Passive House Institute; Professor, Department of Energy Efficient Construction and Building Physics at the University of Innsbruck, Austria

First ever Passive House building | www.passivehouse-database.org ID 0195 | Architects Bott, Ridder, Westermeyer | Darmstadt-Kranichstein | Germany



Big on savings

Energy efficiency lies at the heart of the Passive House concept. Over the course of a year, a Passive House building uses no more than the equivalent of 1.5 litres of oil or 1.5 m³ of natural gas (15kWh) to heat each square metre of living space. This can equate to a more than 90 percent reduction in space heating and cooling energy use as compared to consumption in typical building stock. In comparison, a conventional new build still requires 6 to 10 or even more litres of oil per year and square metre of living space, depending on building quality and location.

Further energy needs

The energy needs for domestic hot water in a Passive Houses are often just as large as if not larger than those for space heating, whereby individual differences in usage can result in large variations for both. In order to further lower energy use and ensure optimal year-round comfort, it is important to choose highly efficient electrical appliances. The approximately 2 kWh/m² a required to run a heat recovery ventilation system is almost negligible.

The beginnings

In May 1988, Wolfgang Feist and Bo Adamson asked themselves how buildings could be designed in a more sustainable, energy efficient way. Drawing on this research and with the help of architects Bott and Ridder, Feist went on to build the first Passive House, completed in Darmstadt, Germany in 1991. In so doing, Feist showed a vision for the future of construction that combined energy efficiency, and thus sustainability, with optimal comfort, affordability, and good indoor air quality. The Darmstadt-Kranichstein terraced house, inhabited by four families, still functions exactly as planned more than two decades later: the measured annual energy consumption has consistently amounted to less than 15 kWh per square metre of living space, year for year.

Future-proof

Over the last two decades, the Passive House Standard has gained rapidly in popularity and has proven to be a reliable approach in an ever increasing range of climates with more than 50,000 units built worldwide according to 2013 estimates. Today, building to the Passive House Standard is not only a sound investment, it simply makes sense.



DECISIVE ADVANTAGES:

1. High levels of comfort
2. Consistent fresh air all throughout the building
3. Structural longevity: mould free buildings with a highly reduced risk of moisture damage
4. Extremely low heating and cooling costs, despite rising energy prices
5. A radically improved indoor environment

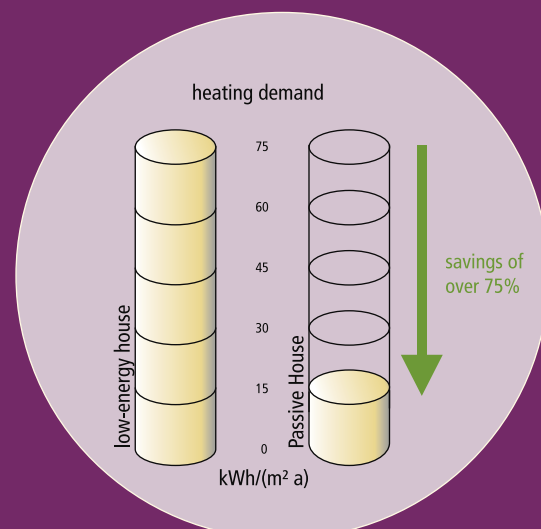

Let the facts convince you!

Passive Houses are far more than just efficient...

Comfortable

Just as a vacuum flask keeps drinks at the desired temperature, the well-insulated envelope of a Passive House keeps indoor areas at a pleasant temperature. Passive Houses are characterised by consistent temperatures on all interior surfaces and constant indoor climates without temperature swings or draughts – during cold winter months as well as hot summer periods.

At the same time, a Passive House building's superior ventilation system ensures ample fresh air at room temperature and makes for high indoor air quality.

Sustainable

By using very little energy from the start, Passive House helps preserve limited resources such as gas and oil. It also makes the use of renewables such as wind and solar feasible: efficient buildings can do more with less, meaning that renewables placed on small surface areas suffice to affordably cover any remaining energy demand. With or without the addition of renewables, a Passive House's high energy efficiency radically reduces CO₂ emissions. As such, Passive House stands as a significant contribution to climate protection.

Innovative

Passive House is a modern building standard that opens up completely new perspectives for architects and engineers. Industry is responding positively to Passive House driven market needs by developing highly efficient, pioneering products and making them available on the market.

Passive House, as such, drives economies and innovation. An investment in comfort and efficiency thus adds value throughout the supply chain.

Reliable

Over the past two decades, tens of thousands of Passive Houses have been built and have performed outstandingly in use. Of these, several hundred have been empirically monitored and rigorously tested. The results have been consistently positive.



Information on Passive Houses that have been built worldwide can be found on the Passive House Database at

www.passivehouse-database.org

Resilient

Passive Houses maintain habitable interior temperatures for weeks, even in freezing weather without power, and thus provide optimal shelter in emergency situations where other buildings would fail. By reducing power demand, Passive Houses also enable stressed power distribution systems to be better managed.

Long lasting

High insulation levels, thermal bridge free design and an airtight envelope, three key aspects needed to achieve Passive House level efficiency, have an additional advantage: high quality building physics. This makes structural longevity an inherent property of Passive House buildings.

Uncomplicated

Passive Houses don't require user manuals to operate. On the contrary, benefits such as pleasant temperatures, no draughts, and ample fresh air result from their very design – no complicated technology needed. In a Passive House, user-friendliness is built in!

Distinct

Passive House is not a building regulation. Instead, people are drawn to this voluntary performance standard by its simplicity and the benefits it brings. Anyone can build to the standard and make a sustainable contribution without cutting back on comfort: the experience, construction products, and planning tools needed are openly available. No matter how basic or unique the design, a Passive House is always something special.

Affordable

Passive House buildings are higher quality buildings. As such, the investment costs are often slightly higher as a result of the more intensive planning and superior components involved. Over the lifespan of the building, however, Passive Houses come out on top: due to their extremely low running costs, Passive Houses are more cost-effective than their conventional neighbours.

Oakmeadow Primary School | www.passivehouse-database.org ID 2953 | Architype Ltd. | Wolverhampton | UK

“We feel that our children are more alert and attentive in lessons due to the amount of daylight in classrooms and the fresh air throughout the school. A bonus is that our gas bill was 90% lower in the first year in our new school than it was in the old building.” | Sara Morris, Head Teacher, Oak Meadow Primary School, UK



You've got questions? We've got answers!

What is passive about a Passive House?

A Passive House requires very little energy to maintain a constant, pleasant temperature. In this sense, such buildings are almost "passive" as they need hardly any active heating or cooling to stay comfortable year-round. Excellent insulation and highly efficient heat recovery systems make this possible. Passive design principles are well known in engineering as effective strategies to achieve a goal with little to no input. Passive security, passive filters, passive cooling and Passive House are examples of the successful implementation of this idea. Of course, none of the aforementioned applications are completely passive in the strict sense of the term as they each require a minor amount of input to guide the respective processes along the desired course. The concept is not as much about letting things happen without using any energy, though, as it is about intelligent design: reaching the desired goal with minimal use of complex systems and non-renewable resources.

Why build airtight? Doesn't a house need to breathe?

The air infiltration through gaps and joints in a conventional building is perceived as draughts. Such "ventilation" is unreliable and uncomfortable. It is also insufficient to ensure healthy

indoor air quality on its own, thus necessitating the opening of windows regularly and for extended periods of time. An airtight building envelope ensures that the ventilation system works as efficiently as possible. Perhaps more importantly, it is also key to preventing moisture damage and mould growth: in conventional buildings, gaps in the building structure allow air to pass through and thereby cool down. This can result in condensate that can put the building at risk. Due to the high level of airtightness, this is not a concern in Passive House buildings!

Can you open the windows in a Passive House?

Of course you can! In a Passive House though, you probably won't feel the need to do so and it is not necessary throughout most of the year. In conventional buildings, occupants must often open the windows, even if it is particularly cold, windy or wet outside, to tackle stale air as well as odours and moisture arising from used towels, plants and wet clothes among other things. To ensure air quality on par with that of a Passive House, windows in conventional buildings would need to be opened at regular intervals day and night, even during the occupants' absences. This is simply not feasible and as a result, most homes, schools, and offices are insufficiently ventilated.

PASSIVE A carafe's insulation helps maintain heat passively

ACTIVE A coffee machine requires constant, active energy input to maintain heat

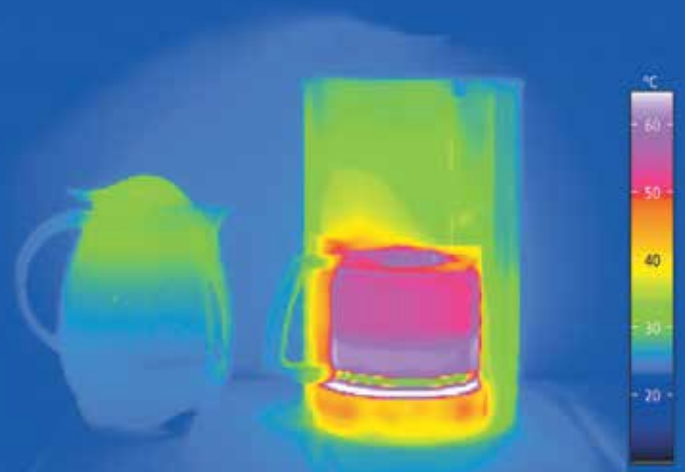

Passive Houses are different. The ventilation system provides for high quality indoor air, automatically extracting moisture and thereby clearly improving comfort. The result is a building with no draughts, no cold corners, and a constant supply of fresh air. Fine filters keep dust, pollen, and other particulate materials out, an invaluable advantage for people who suffer from asthma or allergies.

What's so special about Passive House windows?

Windows not only allow daylight to enter the rooms, they also make use of the sun's energy to warm the building. In cool temperate climates, Passive Houses have noble gas filled, triple-glazed window panes with well-insulated frames. During the winter, such high quality windows let more of the sun's thermal energy into the building than they let out. During the warmer months as well as in warmer climates closer to the equator, the sun sits higher in the sky resulting in reduced solar heat gains just when they're less needed. In most climates, large glazing areas should ideally be oriented towards the equator; windows facing east or west can more easily lead to overheating and provide fewer overall solar gains during the heating period.

Windows need careful planning and, where necessary, appropriate

shading. The window specifications needed to achieve the Passive House Standard depend on the local climate conditions.

How comfortable are Passive Houses in warm conditions?

A Passive House building's very well-insulated walls and roof also serve its occupants well in hot summer conditions by keeping the outdoor heat from entering the building. For the windows, shading in the form of external blinds or sunscreens is critical, as it helps keep the heat from the sun outside. In many cases, cross ventilation through opened windows during cooler periods of the day or night can help passively cool the indoor space. Heat recovery is often not needed during the summer months, and most ventilation systems therefore have a summer-bypass, which helps keep indoor temperatures cool through the summer.

Passive House also functions well in hot and humid climates. In such conditions, many of the same general components and passive strategies, optimised for local conditions, are employed. Ventilation with energy recovery effectively reduces heat and humidity inside the building. In areas where active cooling is a necessity, the application of Passive House principles can dramatically reduce cooling needs.



Want to learn more?



Passipedia, one of the main offerings of the International Passive House Association (iPHA), constitutes a vast array of cutting edge, scientifically sound, Passive House relevant information. iPHA members receive special access to the more in-depth sections of this wiki-based, online compendium of Passive House knowledge – one of the many benefits of iPHA membership. Growing daily, Passipedia is the tool with which new findings from around the world are being presented, as well as where the highlights of more than 20 years of Passive House research are being posted.

www.passipedia.org



An international standard

Energy efficiency for all corners of the globe

Interest in Passive House is growing internationally. While this brochure generally focuses on Passive House in cool temperate climates like those across much of North America and Europe, the Standard is international, remaining both applicable and economically feasible in almost all inhabited climates of the globe. Passive House Institute studies such as "Passive Houses for different climate zones," "Passive Houses in tropical climates," and "Passive Houses in South-West Europe" have shown that Passive House principles remain valid and can be effectively applied internationally. The thousands of Passive Houses built in some 45 countries across the globe are testimony to this fact. Building to the Passive House Standard in any climate is simply a matter of optimising design with local conditions in mind – a task facilitated by the Passive House Planning Package (PHPP), the Passive House energy balance and building design tool.

The keen interest in Passive House beyond Europe's borders has been evinced by the growing number of Passive House buildings and EnerPHit retrofits, refurbishments built according to Passive House principles, globally. Even though certain products required for various extreme climates are not available on the market in every locale, the idea of saving energy while

increasing comfort and air quality has proven incentive enough to carry out new projects in all corners of the globe. As awareness about energy efficiency rises and the demand for appropriate components increases, so does the availability of these products; the associated costs, in turn, sink. These trends repeat themselves wherever the demand for Passive House, and highly energy efficient buildings generally, rises.

The functional definition

The designs of any two Passive Houses in different locations may look quite different. This can be due to varying tastes, building traditions, and climatic conditions. The guiding principle, though, remains that of reducing peak loads to the point at which the building can be heated and/or cooled with the fresh air that must, in any case, be brought in to provide for good air quality. When this is done, both favourable air quality and comfortable temperatures can be ensured.

A highly efficient heat recovery ventilation system is capable of transferring more than 75 percent of the perceived warmth (sensible heat) from the used, exhaust air to the fresh, incoming supply air. On a 0°C day, for example, such systems can make use of the stale exhaust air, already heated to 20°C,

Space Heating Demand	not to exceed 15 kWh annually OR 10W (peak demand) per square metre of usable living space.
Space Cooling Demand	roughly matches the heat demand with an additional, climate-dependent allowance for dehumidification.
Primary Energy Demand	not to exceed 120 kWh annually for all domestic applications (heating, cooling, hot water, and domestic electricity) per square metre of usable living space.
Airtightness	maximum of 0.6 air changes per hour at 50 Pascals pressure (as verified with an onsite pressure test in both pressurised and depressurised states).
Thermal comfort	must be met for all living areas year-round with not more than 10% of the hours in any given year over 25°C .

to bring cold, incoming air to at least 16°C without the use of any active heating.

In climates where cooling is necessary, the same principle applies: the energy recovery system keeps heat and excessive humidity outside while bringing in fresh, cool air at appropriate humidity levels.

Passive House components across the globe

Passive House requires high quality components in order to achieve extraordinary energy efficiency. The properties of these components vary depending on the climatic conditions: Passive House buildings in Scandinavia or Canada will require higher insulation levels than Passive Houses in Mediterranean climates. The mechanical systems may also look very different depending on the climate in which the building is located. The map featured below provides guidance on the characteristic qualities generally required of Passive House components in the world's various climatic regions. Breaking the globe into seven general climate types, the map is based on an economic analysis of what may constitute an optimum in reaching the Passive House Standard with regard to investment costs and energy savings over a building's lifecycle.

For example, in the "warm" climate zone shown in yellow, Passive House can be achieved with moderate insulation, double-paned windows, and the addition of exterior shading devices. In this climate type, it is possible to heat via the fresh, supply air. During warmer times, opening the windows at night for passive cooling may be advantageous. For the cool temperate climate zone shown in turquoise, however, higher levels of insulation along with insulated, triple-paned windows are recommended. Summer shading for this climate is also advisable as is making use of passive cooling via open windows at night. Details on typical Passive House components for these and other climate regions can be found on Passipedia (www.passipedia.org).

These guidelines are of a general nature and do not account for micro-climates, typical of coastal or mountainous regions. For particularly challenging sites or buildings, the ideal Passive House solution may also exhibit properties different to those recommended on the basis of this map. Each building should thus be carefully and individually planned with the help of the Passive House Planning Package (PHPP), using local climate data. Nonetheless, the component specifications given by this map can serve as reliable recommendations, characterising typical Passive House components for any given region of the globe.

Map of Passive House climate regions

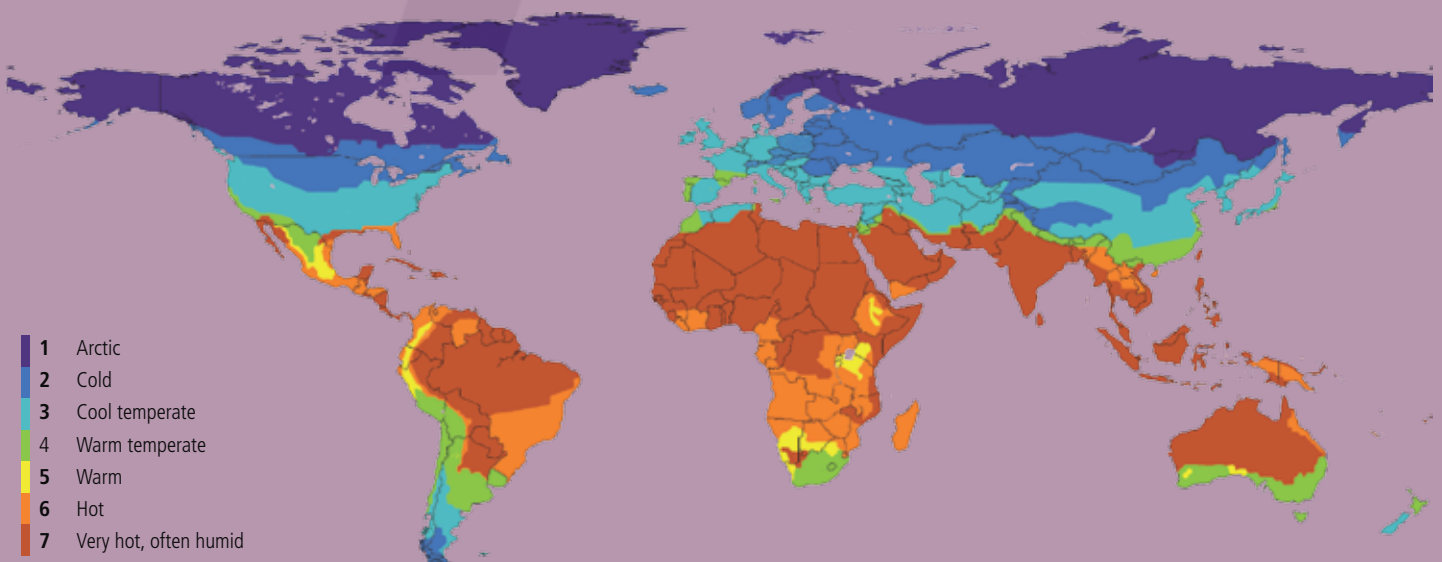

Adapting to local conditions

Different measures for different climates

Much experience on how to build Passive Houses has been gained in Central Europe, the birthplace of the Passive House Standard. It would be unwise, however, to blindly apply successful Central European Passive House design to other regions and climates. Both the advantage and the challenge of the Passive House Standard is that it can and should be applied to regional building traditions and climatic conditions.

Warm and hot climates

In cool temperate climates, the Passive House concept calls for the reduction of peak heating loads so as to facilitate the provision of high comfort levels with simple and reliable mechanical systems. This also serves buildings in warmer climates well in terms of their peak cooling loads. Insulation is crucial, although Passive House buildings in milder climates may need less insulation than those in extremely hot climates. While it is necessary to insulate the floor slab or basement ceiling in cool climates, it is often best not to do so in climates requiring active cooling. This allows the ground to serve as a heat sink in hot conditions, cooling the rooms above. In very hot climates, however, insulation of the floor slab again becomes important.

High quality, insulated windows that are either double or triple-paned, depending on the climate, are essential. In some locations, the use of solar protective glazing is recommended. Exterior shading, whether fixed or moveable, is of critical importance in blocking solar heat gains during the summer period.

Internal heat gains, just as in Passive Houses elsewhere, should be minimised through the use of efficient appliances and lighting. Finally, making use of night ventilation by the opening of a few windows through the night to cool the building has proven to be a very efficient method of passive cooling in locations where humidity levels are moderate.

Keeping cool

In warm climates, active cooling may prove necessary. The passive measures described above help keep cooling needs low so that they may be covered with a relatively small, highly efficient cooling system.



Passive Houses are designed with the help of the Passive House Planning Package (PHPP). As of PHPP version 8, algorithms for the calculation of cooling demand, including dehumidification, have been improved. This facilitates Passive House planning in warm as well as hot and humid climates (see page 46).

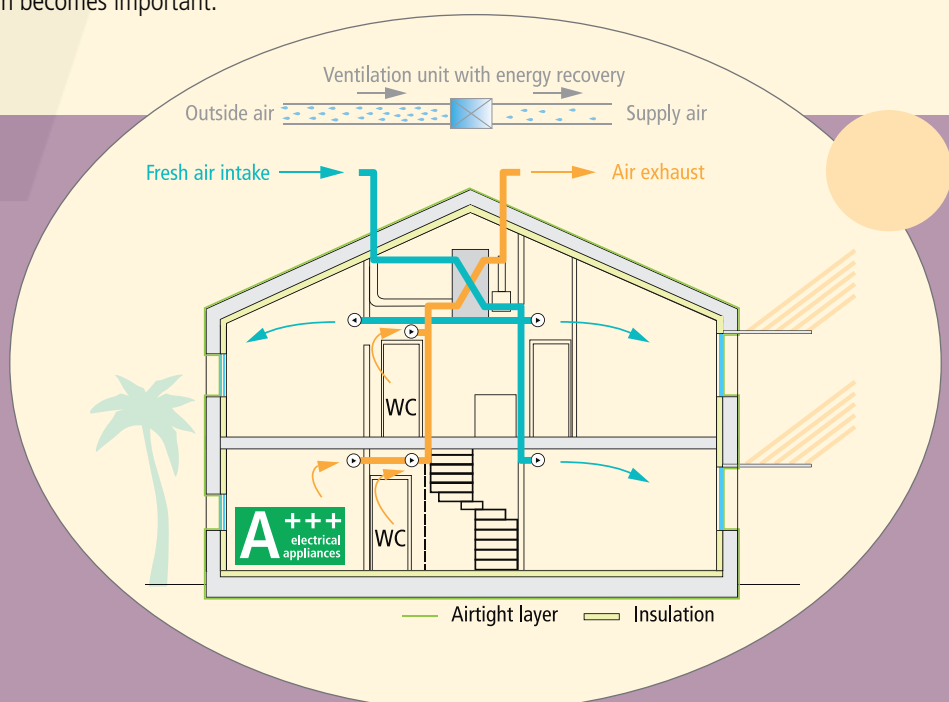

In Passive House buildings, cooling via the air that would, in any case, be supplied by the ventilation system becomes possible with little to no additional cooling via air recirculation. Apart from the reduced energy demand, this also implies higher comfort: with Passive House, noisy, draughty air-conditioning systems are no longer needed!

In climates where not only high temperatures but also high humidity is an issue, dehumidification may be required. Indeed, conventional buildings in hot and humid climates are often over-cooled in an attempt to deal with high humidity.

The excellent level of airtightness in a Passive House help reduce the amount of humid outdoor air entering the building. Ventilation units with energy recovery (heat and humidity recovery) diminish humidity loads even further. In many cases, the remaining dehumidification demand can then be covered by the cooling system. Solutions that allow dehumidification independent of cooling are recommended, in order to avoid unnecessarily high energy consumption.

What about cold climates?

In extremely cold climates, considerations to take into account for Passive House construction essentially build on those typical for cool temperate climates. Excellent insulation of the whole building envelope, including particularly high quality windows, proves increasingly important, as does the avoidance of thermal bridges. High levels of airtightness and highly efficient heat recovery ventilation systems, employed in combination with energy efficient frost protection strategies, are also aspects to consider. Humidity recovery can, for example, be an effective way to reduce the risk of frost-related damage while maintaining adequate indoor humidity so as to ensure comfort.

Locally planned

The Passive House Standard offers a cost-effective, energy efficient and high comfort building solution for almost any part of the globe. The paths that lead to it and thus the design of any particular Passive House building, however, depend greatly on the local climate as well as building traditions, building site, and building type. Appropriate planning is of the essence.

Example of a Passive House adapted to a cold climate

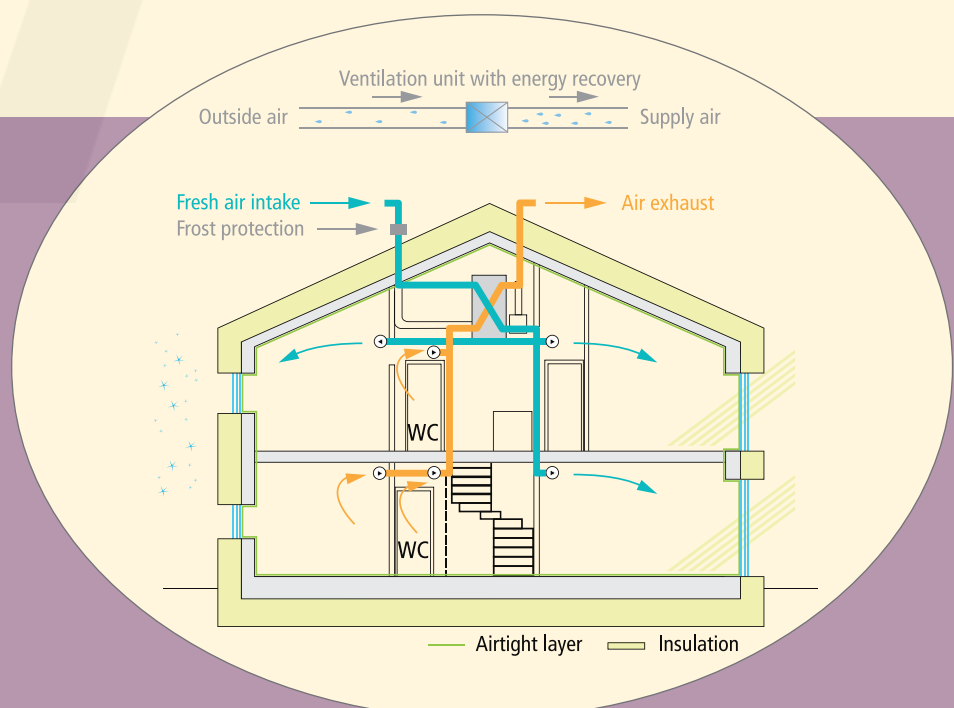

A prudent investment

Do Passive House buildings cost more?

While Passive Houses may come at a slight cost premium due to the higher quality planning and components required, there are also many examples of Passive Houses built at or even below the costs of similar conventional buildings. The availability of affordable components certainly influences investment costs, yet the determining factor for building as cost-effectively as possible often hinges on intelligent design and, more generally, the design team's experience.

Those wanting to build a Passive House must thus carefully coordinate planning from the very start. While thicker insulation layers may cost a bit more due to the additional materials required, the related installation costs do not increase significantly. The costs of higher quality components can be at least partially offset by the reduced dimensions of Passive House heating and cooling systems.

Over the long haul

When combining investment costs with running costs over a building's lifecycle, Passive House buildings usually come out on top, costing less than their conventional counterparts.

Passive House thus make clear economic sense. Reduced energy use translates into lower bills and protection from future energy shocks, making occupancy affordable.

The business case for Passive House becomes even clearer when financial incentives are taken into account, and several countries and municipalities now offer support for buildings built to the Passive House Standard. Many more are just beginning to include this standard in their subsidy schemes, a trend that is sure to continue. Contact your local authority or energy agency to find out about Passive House financial support available in your locale.

Even without such financial support, however, reduced energy costs in Passive House buildings more than compensate for the additional investment costs over the lifetime of the building. When retrofitting as well, aiming for near Passive House efficiency pays off from the start: high quality, energy efficient renovation measures will yield benefits, both economic and otherwise, throughout the building's lifespan.

Single family house | www.passivehouse-database.org ID 2413 | DUQUEYZAMORA Architects | Villanueva de Pría | Spain



Saving costs through energy efficiency

In the long run, a building's energy efficiency is the factor that goes the farthest in lightening financial burdens. Building to the Passive House Standard today is a sensible and rewarding long term investment.

Cost-effective, even in retrofits

Retrofits bring with them some difficult decisions for building owners, for example, when contemplating the replacement of old windows or determining the thickness of insulation to be applied. In most situations though, the money any one energy efficiency measure saves in running costs far outweighs the cost of implementing the measure – and this includes the costs of loans taken out for financing!

The better the quality and higher the efficiency of the measure, the more dramatic the effect. This is why aiming for the EnerPHit Standard for retrofits carried out according to Passive House principles just makes sense. More information on Passive House refurbishments and the EnerPHit Standard can be found on pages 30-39.

Risk insurance

Investing in real estate is about security and the elimination of risks. Compared with their conventional counterparts, Passive Houses are secure investments with a much lower overall risk and a higher total investment value. For one, building to the Passive House Standard is a sure way to avoid structural damage due to moisture and mould, a substantial risk that owners of conventional buildings are forced to take. Banks, too, are starting to see the value that Passive House brings: their low running costs mean clients are less likely to default on monthly payments. Passive House also reduces risk in the face of potential energy price hikes. One of the biggest concerns among conventional building owners and residents, such volatility barely affects Passive House occupants.

Win-win-win

Passive House buildings are high quality products: increased comfort levels, reduced risk of structural damage, and very low energy costs all increase the value of the property. The additional independence from insecure, external energy supplies brings security to the investment. Innovative Passive House products, too, add value through the creation of regional employment.

Diakonissenareal apartments | www.passivehouse-database.org ID 2937 | FAAG Technik GmbH (ABG Holding) | Landes & Partner, B & V Braun Canton Volleth | Frankfurt | Germany

“Within only 3 weeks, 95% of the 55 flats in the ‘Campo am Bornheimer Depot’ project were sold or booked... The 111 owner-occupied Sophienhof flats were sold in record time.” | Frank Junker, Director of ABG FRANKFURT HOLDING GmbH, housing company and developer



Expertise you can trust

The proof is in the certificate



The principles behind Passive House are straightforward. When it comes to building design and planning though, attention to detail is essential to ensuring both that the desired energy savings are actually achieved and that the building will perform as planned. Proof that a building has been designed and built to the Passive House Standard, in the form of building certification, is thus a significant quality assurance step.

Any of the over 30 Passive House Building Certifiers, each accredited by the Passive House Institute, may certify buildings anywhere in the world in the Institute's name according to the internationally recognised Passive House Standard. The same holds true for retrofits with Passive House components according to the EnerPHit Standard. The Institute itself also carries out building certification, especially on projects of particular research interest dealing, for example, with novel building types and demanding climates. In addition to the certificate, a special plaque denoting certification may be affixed to the façades of Certified Passive House Buildings and Certified EnerPHit Retrofits. A list of accredited Building Certifiers can be found under the certification section on www.passivehouse.com

The right skills in planning



Whether in terms of insulation, airtightness, or mechanical systems, building a Passive House requires competent planning. Certified Passive House Designers and Consultants have an important role to play throughout the design phase and in the lead up to potential certification. Whether through an exam or the careful documentation of work on a Certified Passive House Building, these professionals have proven Passive House knowledge in their respective fields of expertise.

Individuals qualified to sign off on building or mechanical system plans receive the title of Certified Passive House Designer upon successful certification where as those without such authority are designated as Certified Passive House Consultants. Several thousand experts around the world have already attained this internationally recognised, Passive House Institute qualification. Certified professionals can be found on www.passivehouse-designer.org



The right skills onsite



Putting well-thought out plans into action takes skill. To ensure quality results, it is critical that onsite construction professionals also be versed in aspects of the Passive House Standard relevant to their work. The Certified Passive House Tradesperson qualification facilitates much needed quality assurance on the construction site.

The certification is attainable through course work and an exam developed by the Passive House Institute; both are being delivered in an increasing variety of languages and countries. Individuals can either specialise in mechanical systems or the building envelope, dependent upon their background and interests. Hundreds of professionals worldwide have already achieved this qualification – a boon to the high quality work needed on a Passive House building site. An overview of all certified craftspeople can be found at www.passivehouse-trades.org

Navigating the field



Whether Certified Passive House Consultant, Designer, or Tradesperson – all professionals are required to keep their knowledge up to date by demonstrating work on a Certified Passive House Building at least every five years. As a seal of Passive House expertise, these certifications, taken together with other relevant professional qualifications and a professional's background, make it easier to navigate the field. They help anyone wishing to build get the Passive House quality they expect at minimal cost.

Many certified professionals, accredited Building Certifiers, Passive House course providers, and other Passive House stakeholders are members of iPHA, the International Passive House Association. Founded by the Passive House Institute with thousands of members from some 50 countries, iPHA is a global network that works with affiliated local Passive House networks worldwide to promote the Passive House Standard and foster a greater public understanding of its significance. Encouraging the exchange of Passive House knowledge, iPHA communicates with the media, the general public, and the entire range of construction professionals. www.passivehouse-international.org

Passive House Institute

The Passive House Institute (PHI) stands as the global centre of excellence in the Passive House sector, working to combat climate change through the advancement of energy efficiency in construction. In addition to its trainings and professional certifications, PHI has facilitated the uptake of Passive House worldwide through its rigorous certification of Passive House buildings and building components as well as through the development of the Passive House Planning Package (PHPP), the cornerstone energy balancing tool with which Passive House buildings and EnerPHit retrofits are planned (see page 46 for more information). Since its founding in 1996, this research institute has published numerous findings on all aspects of Passive House construction. www.passivehouse.com





02

DETAILED INFORMATION

- 20 Thermal bridge free and airtight
- 22 Passive House windows
- 24 Superior ventilation
- 26 Passive House – not just for houses
- 31 Local authorities take action
- 32 Retrofit for the future
- 40 Efficiency – the key to green building
- 44 Maximum benefit, minimal cost
- 46 Quality is fundamental
- 47 Easy comfort

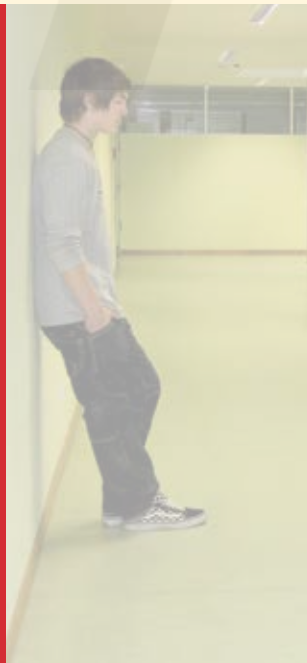

Thermal bridge free and airtight

Stopping energy leaks

Building envelopes consist not only of “unbroken” construction elements like walls, roofs, and ceilings, but also include edges, corners, connections, and penetrations. Energy can pass through these points in the building much more easily than throughout the rest of the building envelope, a phenomenon known as thermal bridging. Preventing thermal bridges is one of the most efficient energy savings measures there is. Observing some simple rules can help reduce losses caused by such thermal bridging.

For example, a balcony formed by simply extending a concrete ceiling inevitably leads to additional heat losses because it penetrates the insulation layer and thus allows heat to pass. In such cases, the use of a thermal break element must be planned to minimise this effect. One possible solution would be to affix a free-standing balcony to the façade.

Passive House emphasises thermal bridge free construction whenever possible. The aim is to reduce thermal bridge effects to the point that they are so insignificant, they no longer need to be taken into account in calculations. Many products, developed especially for this purpose, are now available on the market.

Stopping air leaks

Ensuring that the building envelope is airtight reduces the risk of structural damage. Airtight buildings can be achieved through careful planning and intelligent solutions such as full interior plastering, the use of sheeting, reinforced building paper, or wood composite boards. Quality workmanship and the proper installation of all airtight building components such as windows and doors are also important.

“ We have an exceptionally good indoor climate. I’m very sensitive to draughts. Here there aren’t any, which is why I feel the cold even more when I’m staying anywhere else. | Wilma Mohr, Passive House resident since 1991, Germany ”

»» The airtight layer in a Passive House (green line) seamlessly encloses a building’s thermal envelope. It should be possible to draw a continuous line of airtightness without ever lifting your pencil. For each detail, the materials to be used and the connections to be made should be defined during the planning phase.

A similar pencil rule also applies to the thermal bridge free insulation layer (yellow). Unavoidable penetrations should involve components and materials with minimal thermal conductivity.

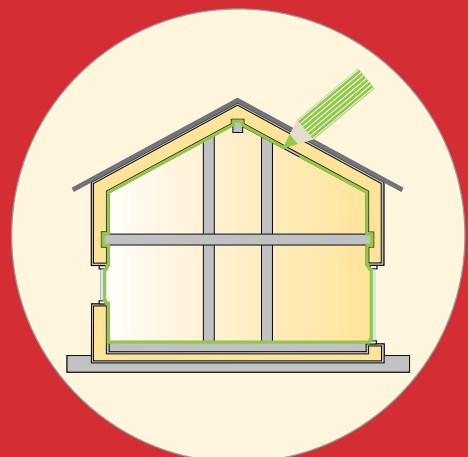

Leave nothing to chance

In an airtight building, air does not flow randomly through the walls of the building envelope. This is important, because air flow driven by the wind and by temperature differences is not sufficient to provide consistently good air quality. This random air flow is not only uncomfortable, at times providing too much air and often too little, it can also lead to structural damage with leaks in the building envelope allowing warm, moist air to flow through the walls.

As the passing air cools, the moisture therein condenses, causing mould and structural damage. Poor acoustic insulation and significant heat losses are further disadvantages of leaky buildings. Airtightness, on the other hand, helps prevent draughts, cold pockets, and structural damage resulting from gaps in the façade. A ventilation system guarantees the right amount of fresh air in a controlled manner.

Under pressure

Airtightness is one of the most economical measures one can undertake in making a building energy efficient. Luckily, it is relatively straightforward to construct buildings in an airtight way, although careful planning is needed. For each Passive House building, an airtightness test or air pressure test is carried out to ensure the stringent Passive House airtightness requirements are met. The test is performed by measuring the total air leakage in the building while under positive pressure and then again under negative pressure.

This pressure test, essential when building to the Passive House Standard, is best conducted as early as possible so that any leaks detected can be easily sealed. This effort is well worth it; buildings that are airtight have many advantages including better acoustics, reduced energy requirements, and increased levels of comfort without the risk of draughts and structural damage.

Airtight connections between wood composite boards



Fan for an air pressure test



Passive House windows

High quality frames and glazings

As the weakest part of the building envelope, windows deserve special attention in Passive House buildings and it is essential that the windows installed are of very high quality. Depending on the climate, various levels of frame insulation and different glazing characteristics may be required to ensure that thermal comfort demands for living and working spaces are met. The average temperature of internal window surfaces, however, should not fall below 17°C on a cold day, without the aid of radiators placed under the windows.

This comfort guideline ensures optimum thermal comfort even in a window's direct vicinity. In cool temperate climates, for example, highly insulated frames and triple low-e glazing are required, resulting in U-values of less than 0.85 W/(m²K) for an installed window (see the component map on www.passipedia.org for typical U-values in other climate regions).

The window frame plays a particularly important role in this constellation. For typical window sizes, the frame accounts for between 30 and 40 percent of the total window area. In most cases, slimmer frames and larger glass surfaces are preferable as the thermal performance of glass is better than that of the frame. Higher glass-to-frame ratios thus allow for higher solar gains.

Frames should not only be slim, they must be insulated; heat losses through conventional window frames are much higher than those through insulated ones. The additional heat losses at the edges of the glazing are also considerable in conventional window frames and can be greatly reduced if a thermally improved edge seal is used. A well-insulated frame is thus necessary for high quality windows. Triple low-e glazing and insulated frames, as per the above specifications, are a must in cool temperate climates while in warmer climates, a window with double low-e glazing and a moderately insulated frame is often sufficient. In colder climates, quadruple glazing and further improvements in frame insulation may be required.

Installing windows in the insulation layer minimises thermal bridges; extending insulation over part of the frame reduces heat losses. Installation cross sections in solid and timber frame walls.

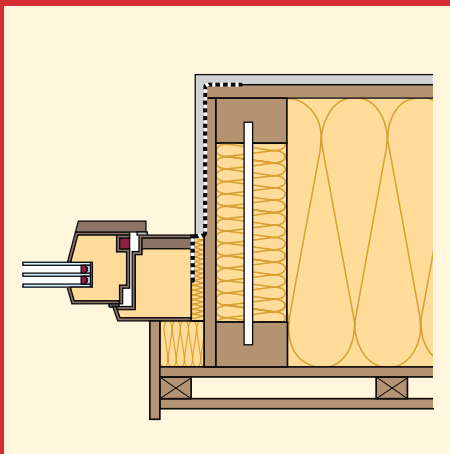
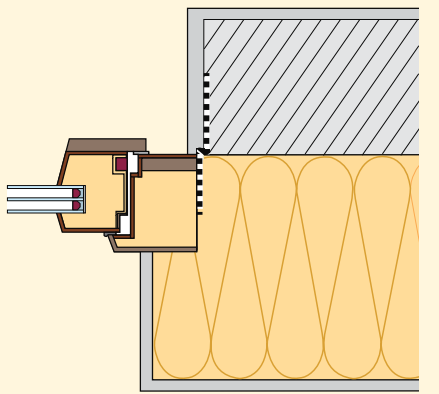

Preventing thermal bridges for maximal comfort

Significant thermal bridges can occur if a window is installed incorrectly in the wall. Windows in Passive Houses must thus be skilfully placed within the wall's insulation layer to minimise thermal bridge effects. This generally includes extending the insulation so that it overlaps connections in the window frame. In cold and cool climates, this helps prevent heat losses and raise the internal surface temperatures at these junctures. In hot climates, the overlapping insulation helps keep the building cool by reducing internal surface temperatures.

Use of solar energy

The solar radiation that enters a building through its windows brings with it both light and warmth. This warmth can prove indispensable in the winter months but the amount that stays in the building depends heavily on the quality of the windows installed. Passive House quality windows minimise heat losses, allowing for optimal use of passive solar energy. This not only

leads to energy savings, but also makes for attractive and healthy living conditions. The amount of passive solar gains that enter a building in the first place, on the other hand, depends on that building's location as well as the distribution and orientation of its glazed areas. Experienced designers know how to optimise these aspects in their planning, and can build Passive Houses even in locations that receive little sunshine.

Avoiding overheating

During warm periods in any climate, the emphasis lies on limiting solar gains and thereby keeping the indoor environment comfortably cool. With large windows often forming an integral part of contemporary architecture, shading becomes all the more crucial. In hot climates where heating is not needed, solar protective glazing proves effective in reducing the solar heat load. Such glazing allows visible light to enter the building while keeping heat out by filtering infrared and ultraviolet waves, known as "spectral selectivity." Passive Houses in hot climates should typically have windows with a selectivity of 2 or higher.

When I watch my son on a cold winter's day playing comfortably in front of our picture window wearing only his diaper, I know that Passive House was the right choice for my family. | Owner, designer, and builder Lukas Armstrong, Nelson, BC, Canada

Insulated window frames that are suitable for Passive Houses are available in a variety of materials ensuring that everybody's preferences can be met. There are currently over 200 Certified Passive House Windows and related components on the market.



Superior ventilation

Ventilation with heat recovery

The ventilation system plays a crucial role in Passive Houses: it provides clean, pollen free, dust free air while eliminating excess moisture and odours where they occur. Opening windows to achieve this, on the other hand, would typically result in heat losses greater than the total energy demand of a Passive House building.

Heat recovery ventilation systems are therefore indispensable in colder climates. Inside the heat exchanger, heat from the warm, stale air (extract air) is passed on to the cold, incoming, outdoor air, thus reducing heat losses considerably. In extreme summer heat, this system can even work to a certain extent in reverse, pre-cooling the fresh air that is supplied to the building. Depending on the efficiency of the heat exchanger, over 90 percent of the heat can be transferred, allowing the supply air to come in at nearly room temperature.

High quality ventilation systems ensure that the supply and exhaust air ducts in the heat exchanger are leak proof, so that fresh and used air are never mixed. These high quality ventilation systems save much more energy through the prevention of heat losses than they use to run.

Intelligent layout

To ensure optimal function, the ventilation system as a whole must be carefully designed. Air should flow into the living room and bedrooms of a house and be extracted through rooms where moisture and odours build up, such as the kitchen and bathrooms. These areas are connected by air transfer zones, consisting of areas such as hallways. In this way, fresh air is imperceptibly directed throughout the building.

To ensure that closed doors do not hinder air flow, appropriate air transfer openings such as covered panels with acoustically optimised vents must be integrated in the door or door frame. A high quality Passive House ventilation system is incredibly silent with sound levels no higher than 25dB(A). To comply with this limit, the supply and exhaust air ducts are fitted with silencers that prevent sound transmission between rooms.



Clean air and a pleasant indoor climate

Operating and maintaining a ventilation system with heat recovery is easy. For hygienic reasons, the outside air intakes of these systems are fitted with high quality filters while their exhaust air valves are fitted with coarse filters. These filters should be replaced regularly, between one and four times a year, depending on building location (inner cities tend to have more polluted air than rural areas).

In most climates, even Passive Houses require some heating, but the heating demand is so small that the ventilation system can also be used to distribute heat throughout the house. Heating coils can make up for remaining heating needs by warming the incoming fresh air. Compact heat pump units, combining heat recovery ventilation with heating, hot water supply, and storage in one unit, have been approved for this purpose. These space saving devices come ready-made and are both optimised and easy to install. Other solutions are also available: gas, oil, district heating, or wood, for example, can be used for heating and hot water needs.

The use of solar collectors for the provision of domestic hot water is also an interesting option that can even further reduce energy consumption.

During warm, mild seasons, heat recovery is not needed as it would trap the heat inside the building. Ventilation systems are therefore equipped with a so called summer bypass, which disables heat recovery to directly convey cool, outside air indoors. With automated control of the bypass, the heat recovery potential can be maximised throughout the year and in different climates.

Under more extreme climatic conditions, for example, when it is very hot, heat recovery once again becomes important in terms of energy savings and comfort. The same holds true for very humid conditions. A ventilation system with heat or energy recovery ensures fresh air inside the building, blocking excessive heat and humidity from entering. The incoming air can then be further cooled or dehumidified, if needed.



The basic principle of Passive House ventilation: moist, stale air is extracted from the kitchen and the bathrooms (extract air) while fresh air (supply air) flows into the living areas. As a result, the hallways are automatically ventilated. As a general rule, the ventilation system should be designed to provide 30 m³ of fresh air per person per hour. For a living space of 30 m² per person, this equates to a supply air volume of 1 m³/(m²h). The maximum temperature to which this supply air can be heated is limited to 50°C so as to avoid odour problems resulting from burnt dust particles. The resulting maximum heating load amounts to 10 W/m², which can easily be met via the supply air.

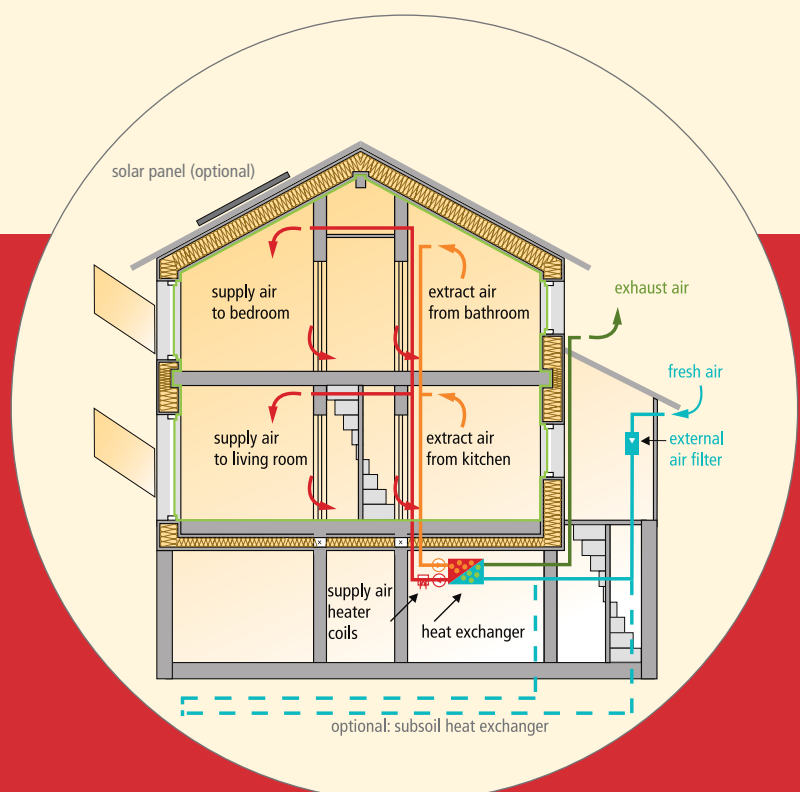

Passive House – not just for houses

Non-residential Passive House buildings

Whether school, hospital, office building, supermarket, industrial facility, or commercial complex – almost any building type can be built to the Passive House Standard. The principles remain the same as in residential building, yet the benefits can, in many cases, be even more significant. Built examples demonstrate this in both non-residential new builds and retrofits. Key to the functionality of these buildings, which are typically used intermittently by large numbers of people, is a well-designed ventilation system.

When designing non-residential Passive Houses, it is important to keep the building type and its use profile in mind. A kindergarten must be planned very differently from a manufacturing plant and the planning of a government ministry will require different considerations than for an indoor swimming pool, a bank, or a fire department. This said, the key principles remain the same: optimal insulation of the building envelope ensures minimal influences of outdoor temperatures on indoor climates while efficient ventilation systems provide high quality air with minimal energy losses.

Windows opened, windows closed

No one is a stranger to those arguments in the classroom and at the workplace about whether the windows should be opened for fresh air or kept closed to maintain indoor temperatures. Especially during the winter, it is usually those most sensitive to the cold who ultimately prevail, and the result is poor indoor air quality. In Passive House buildings, it's not necessary to worry about airing out rooms on a regular basis: controlled ventilation constantly provides fresh air at comfortable temperatures and without draughts so that everyone's needs can be met.

For non-residential Passive House buildings, just as for their residential counterparts, heat recovery ventilation is necessary in most of the world's climates. In cold conditions, the heat exchanger withdraws heat from the warm extract air and transfers it to the cold incoming fresh air, thus pre-heating the air being fed into the rooms. Even the high quantities of fresh air typically required in non-residential common areas can be delivered without any draughts in this way.

Certified skyscraper | www.passivehouse-database.org ID 2860 | ARGE Atelier Hayde Architekten and Architektur Maurer | Vienna | Austria



“ We are extremely proud that the RHW.2 stands as the world's first skyscraper built and certified to the Passive House Standard. The building makes use of available resources – the sun, water, earth, and air – and even produces a large part of the energy it consumes.” | Klaus Buchleitner, CEO Raiffeisen Holding und Raiffeisenlandesbank NÖ-Wien, Vienna Austria

Keeping cool

Just as in residential Passive House buildings, it typically makes sense to ventilate via open windows during mild seasons, so long as it is not excessively humid outside. A sufficient number of openable windows should always be planned for this purpose. Motorised ventilation flaps can be used on cool summer nights, even when people are not in the building, to help ensure a comfortable indoor climate during the day. Alternatively, the summer bypass mode, present in most heat recovery ventilation systems, can be used to bring in cool air when windows cannot be opened at night due to, for example, security reasons.

Despite the higher heat loads that non-residential buildings often face, when designed well, most non-residential Passive Houses in cold, cool, and temperate climates can be kept cool with a combination of targeted window ventilation and adequate shading. A well-insulated building is generally easier to keep cool than a conventionally built one and the use of massive building materials, particularly in the ceilings of each storey, can further dampen temperature peaks. Light-coloured or even reflective façades further help keep the heat at bay, especially in climates with long, sunny summer seasons.

Mechanical ventilation may then be switched on as a support measure during events with many participants or when odours are present, as is the case in some manufacturing processes.

Non-residential buildings often have higher cooling demands than their residential counterparts due, in part, to their use patterns and the prevalence of electrical devices. If passive measures are not enough to keep a building comfortably cool during the warm season, further cooling can be provided without too much effort via the ventilation system itself, by cooling the incoming supply air with a cooling coil, or through adiabatic cooling. The low volume flow in a Passive House makes recirculation cooling possible without fear of draughts or noise disturbances. The pre-cooling of incoming fresh air via a geothermal heat exchanger is often a cost-effective, sustainable approach to reducing cooling loads. Surface cooling, for example, through concrete core activation, can further serve as an efficient alternative or supplement to air-based cooling. Generally though, a Passive House's low cooling requirements and dampened loads allow for a range of highly efficient cooling solutions.

Kindergarten | www.passivehouse-database.org ID 1746 | Michael Tribus | Merano | Italy



Synergies through efficiency

Reducing electricity use

When designing for efficiency, it is essential to not only take the building envelope and mechanical systems into account, but to also reduce electricity consumption as much as possible. This becomes particularly important in non-residential buildings, where electric devices such as computers abound and lighting become a key issue.

Daylighting

Intelligent use of daylight with carefully planned windows is perhaps the most significant step in using electricity efficiently. Preventing protrusions that cast shadows on the ceiling, shading systems that enable light to be directed where it's needed most, as well as bright, reflective surfaces all allow light to penetrate farther into the room. Additionally, glare reduction, for example, in the minimisation of windows that face due east and due west, is an aspect that should be taken into account when designing energy efficient non-residential buildings.

Lighting systems and electrical devices

The efficient use of daylight in schools and work spaces should go hand in hand with the planning and installation of efficient lighting systems. Making use of energy saving bulbs or LED technology, for example, can go a long way toward energy savings and the reduction of heat loads. Ensuring that such systems can be regulated according to the time of day and type of use is a central theme in keeping electricity consumption for such buildings consistently low.

The application of energy efficient computing and telecommunication technology is also not to be overlooked. Today's standard computers, for example, still unfortunately consume about four times as much energy as efficient laptops.

Efficient electrical devices and lighting systems along with effective daylighting not only cut running costs but also reduce heat loads in the building. This positively affects indoor

“ We have achieved Passivhaus at no extra cost, and within a tight budget and timescales. Our new schools are benefiting from increased internal comfort, and hugely reduced running costs and carbon emissions from day one. | Jeff Southall, Wolverhampton City Council BSF Project Officer, UK

Bushbury Hill Primary School | www.passivehouse-database.org ID 2955 | Architype Ltd | Wolverhampton | UK



temperatures during the summer, regardless of whether an additional cooling system is in place. If active cooling is required, reducing electricity consumption often makes it possible to downsize and simplify needed cooling systems.

Passive House schools: where parents learn from their children

Schools were one of the first non-residential building types to which the Passive House concept was successfully applied. There are now many built examples of Passive House schools and much experience has been gained from their use.

The results from field measurements show that controlled ventilation leads to a significant improvement in indoor air quality in any building. These measurements also show that the high potential for energy savings can be tapped by greatly reducing heat distribution losses and optimising heat gains. This is especially true in the construction of schools.

As with residential Passive Houses, high quality Passive House windows have consistently almost room temperature interior panes, even in the coldest of outdoor conditions. This characteristic results in the pleasant side effect that radiators under each window are not needed; instead, the space near the windows can be fully used. In the classroom, this means better use of daylight and more room for students.

An optimal indoor climate for students and teachers paired with low running costs for the community – with Passive House schools, the next generation can learn about energy efficient and sustainable building practices through their daily surroundings. School buildings provide an ideal opportunity to both address the topic of energy efficiency and to gain first hand experience with it.

>> Further information on schools as well as non-residential buildings in general can be found at www.passivehouse.com and on Passipedia at www.passipedia.org

Ventilation in schools

The effects in schools without ventilation systems are well-known. Numerous air quality measurements have confirmed that in conventional schools, the concentration of CO₂ only 30 minutes after classes begin often already exceeds 1500 ppm. We can't speak of satisfactory indoor air quality above this value. Without active ventilation, the concentration of CO₂ continues to rise until, towards the end of a 2 hour lesson, it reaches about 4000 ppm. Although CO₂ itself is not harmful in these concentrations, such high levels often negatively impact the students' concentration and performance. Additionally, a high CO₂ level tends to be an indicator of poor air quality as it is correlated with many other indoor pollutants. In order to achieve satisfactory air quality via the windows alone, one would have to open them completely, every 25 minutes, for several minutes at a time.

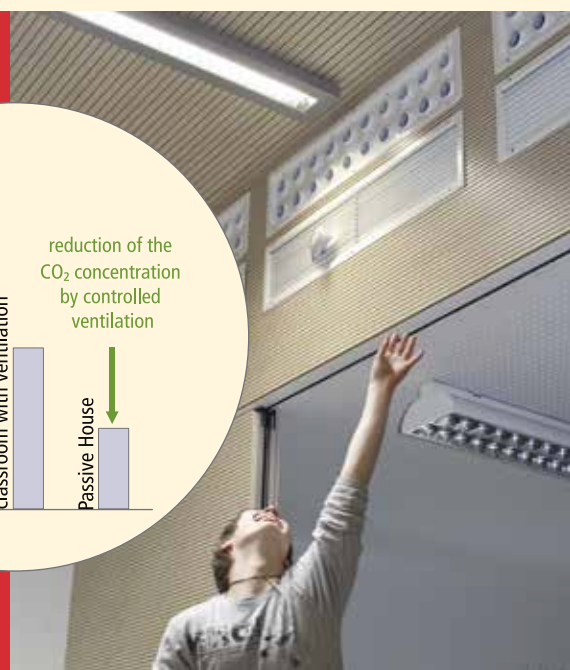
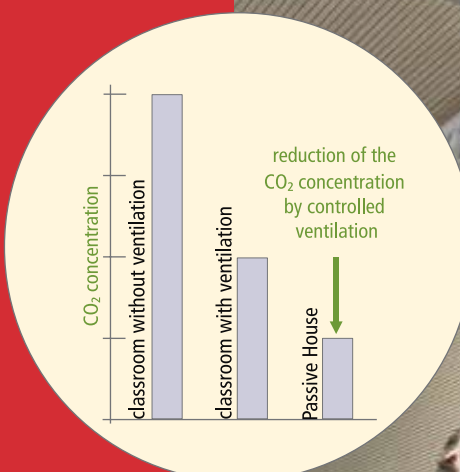

A multitude of possibilities

Retrofitting non-residential buildings

Existing non-residential buildings can also be refurbished using Passive House principles according to the EnerPHit standard (see page 32 for details). Such renovations can prove particularly attractive: using Passive House components to renovate existing buildings leads to increased comfort and a significant reduction in energy demand, often by a factor of 10. The additional investment required to improve efficiency in existing buildings can often be recovered through the savings in running costs.

Special use buildings

Today, non-residential buildings built to the Passive House Standard come not only in the form of office buildings and schools, but also as supermarkets, museums, laboratories, fire stations, and hospitals. In Passive House supermarkets, for example, the focus lies on energy efficient refrigeration just as a focus on efficient machines is critical for Passive House hospitals. Appropriate lighting solutions should be considered, both in terms of daylight and artificial light. Adequate and efficient ventilation is also important. Systems that automatically switch

on and off according pre-defined cycles that make sense for a building's use profile and outdoor climate can also be helpful. In terms of the building envelope, the Passive House principles of good insulation, controlled ventilation, and airtightness provide the basis for high overall building performance and ensure superior levels of comfort. Adding renewables such as PV arrays is highly recommended for such buildings, which often consume large amounts of electricity: such visible renewable energy systems not only help send a message to customers but also contribute to keeping energy bills low.

Quality is the top priority

Well-documented experience with the Passive House Standard for office buildings and other building uses has shown Passive House to be an attractive standard for an impressive variety of projects. For buildings with unavoidably high internal heat loads or high indoor pollution, special tests are recommended, where necessary, to ensure that the quality, energy efficiency, and comfort expected from the Passive House Standard are met.

Certified Passive House Supermarket (www.passivehouse-database.org ID 3930) | Spengler and Wiescholek architects (property developer Meravis Wohnungsbau- und Immobilien) | Hanover | Germany



Local authorities take action

Going passive

Numerous regions and municipalities have already adopted Passive House as a binding requirement for all new public building projects, not in the least because a significant contribution can be made to climate protection in this way with very little extra effort. One of the first such municipalities, Frankfurt (Germany) passed legislation as far back as 2007 ensuring that all new builds built by the city or for the city be constructed to the Passive House Standard. Communities, cities, and regions that, like Frankfurt, have decided to promote Passive House by setting an example with their own public buildings, are rewarded continuously by extremely low running costs. This benefit enables them to divert funds to other important endeavours.

Other regions have not only followed this approach, they have gone even further by mandating Passive House not only for public buildings, but for all buildings in general. In Belgium, for example, the Brussels Capital Region has made the standard mandatory for all new builds as well as all retrofits, whether public or private and whether residential or non-residential, as of January 2015.

While not necessarily having written Passive House into law, a variety of communities have recognised the advantages of the standard and officially support Passive House construction, either financially, by recognising the standard in their building codes, or through the provision of information and consulting. The very high density of Passive House buildings visible in Hanover (Germany) as well as the region of Tyrol (Austria), for example, is due in no small part to the financial incentives and informational material on offer in both locales.

It is clear that the number of local authorities taking notice of the Passive House Standard and the benefits it brings is on the rise. The above are but a few examples of various model cities and regions worldwide.

>> To find out more about front-running Passive House regions, have a look at the findings of PassREg, an EU-funded project on Passive House regions www.passreg.eu, also available on Passipedia www.passipedia.org.

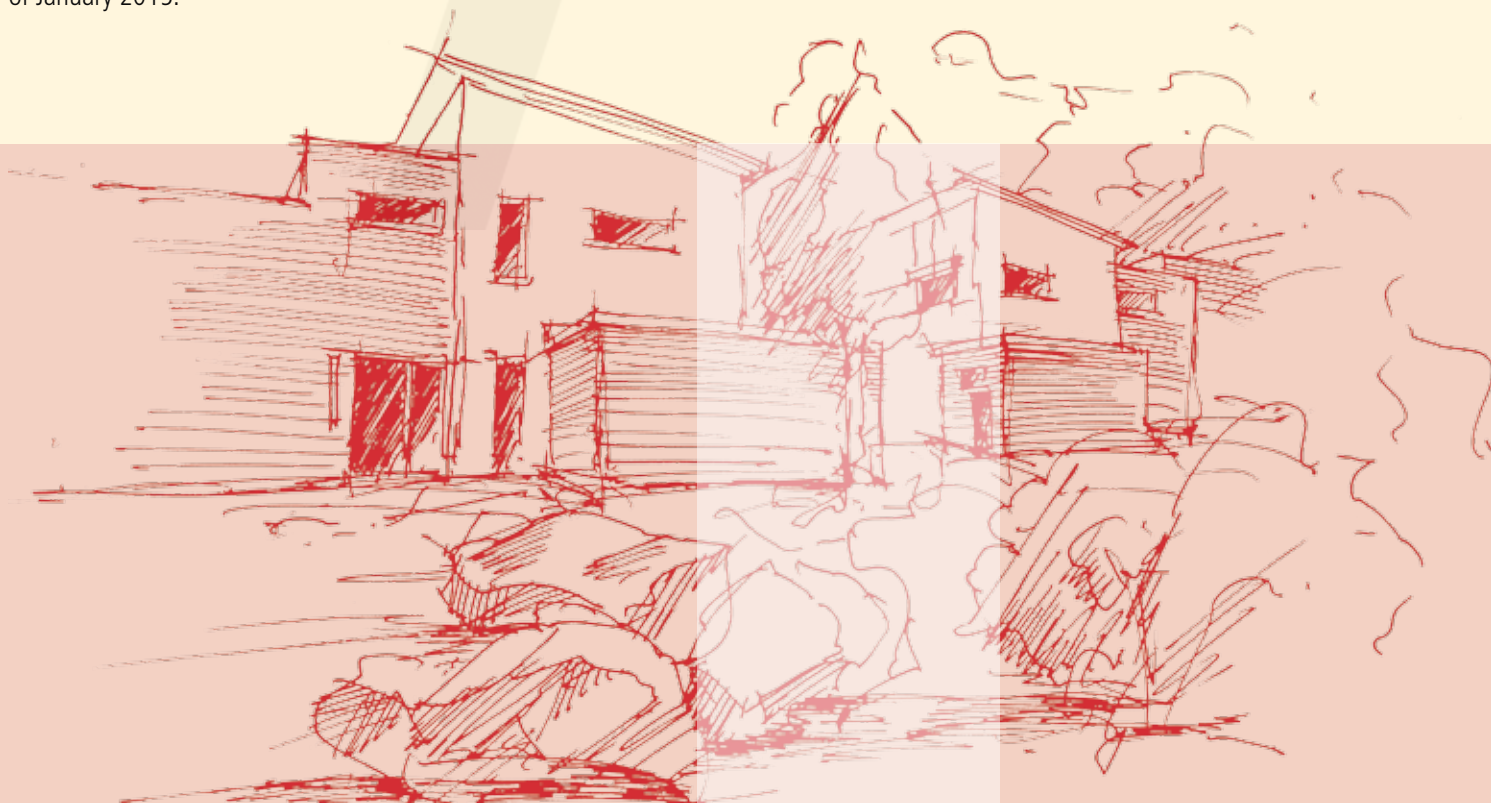

Retrofit for the future

Why refurbish?

In many developed countries, a larger number of buildings are being refurbished than being newly built each year. Most people in such areas will therefore continue to live and work in already existing buildings over the next few decades. As older buildings use even more energy than conventional new builds, they offer an even greater potential for energy savings. What works for new buildings can be applied to existing ones as well, and this is good news, as deep energy refurbishments are both profitable and further reduce our dependence on energy imports. Additionally, retrofitting an existing building with Passive House components, based on Passive House principles, brings almost all the advantages of a Passive House new build.

Passive House retrofitting with EnerPHit

Renovations according to Passive House principles are made possible by retrofitting to the EnerPHit Standard. Developed by the Passive House Institute in 2010, the EnerPHit Standard is especially designed for retrofits. Unlike in new builds, retrofits often come with challenging conditions that make the Passive

House Standard prohibitive. Built-in thermal bridges, sub-optimal building orientation, and non-compact building designs, for example, are aspects that are often impossible to correct in existing buildings. EnerPHit makes allowances for this while remaining true to Passive House principles and ensuring that a building's comfort levels, structural longevity, and energy efficiency are drastically improved.

Buildings meeting the EnerPHit criteria must either exhibit a heating demand of no more than 25 kWh per square metre of living space and year (as opposed to 15 kWh/m²a for the Passive House Standard) or be fitted with Passive House suitable components. At the time of printing, this certification can only be granted for buildings in cool temperate climates. The certification requirements for all other climate zones of the globe are, however, currently under development and will come into effect in 2014. They will have their foundations in the climate-based component criteria developed by the Passive House Institute (see map on page 11).



Victorian-style row house renovated to Passive House level I www.passivehouse-database.org ID 2034 | paul davis + partners | London | UK



More information and certification criteria can be found under the building certification section of the Passive House Institute website

www.passivehouse.com

The cost of energy saved

The additional expenses for an EnerPHit refurbishment using Passive House components naturally differ from building to building and region to region. The deep refurbishment of an apartment complex, for example, will typically cost less per square metre of living space than for a single family house due to the house's less favourable geometry.

For energy retrofits to be cost-effective, it is crucial to optimise the renovation measures that would have, in any case, been necessary. If the façade needs to be renovated, for example, because the exterior plaster is cracked, costs for scaffolding and façade improvement will be incurred. Adding (better) insulation during this same step would result in very low additional costs. These additional costs, spread out over the lifespan of the component, can then be compared to the energy saved by that component annually. This realistic calculation of the costs and benefits of any retrofitting measure can be applied to the refurbishment of the roof, the windows, the basement ceiling, and so on.

Is refurbishment worth it?

Retrofitting to the EnerPHit Standard with Passive House components and principles also increases the value of the building considerably. A building that has been refurbished with an eye to energy efficiency as well as high comfort levels and low running costs is significantly more attractive for tenants and buyers. The chances of successfully renting out the property or selling it improve considerably.

Optimally refurbished buildings lessen both the financial burden carried by their occupants and the environmental impact. Energy retrofitting is thus an undertaking that is often supported regionally and nationally through financial assistance programmes, either in the form of low interest loans or as direct subsidies. Such programmes help mitigate the somewhat greater investment costs of high performance retrofitting. With or without such support, however, well-planned EnerPHit retrofits with Passive House components are worthwhile, not only because of the energy savings they bring, but also because of the improved comfort and reduced risk of structural damage that come with them.

Thermal image of a 1899 Brooklyn brownstone renovated to Passive House level on a cold evening | www.passivehouse-database.org ID 2558 | Fabrica718 | Brooklyn, New York | USA

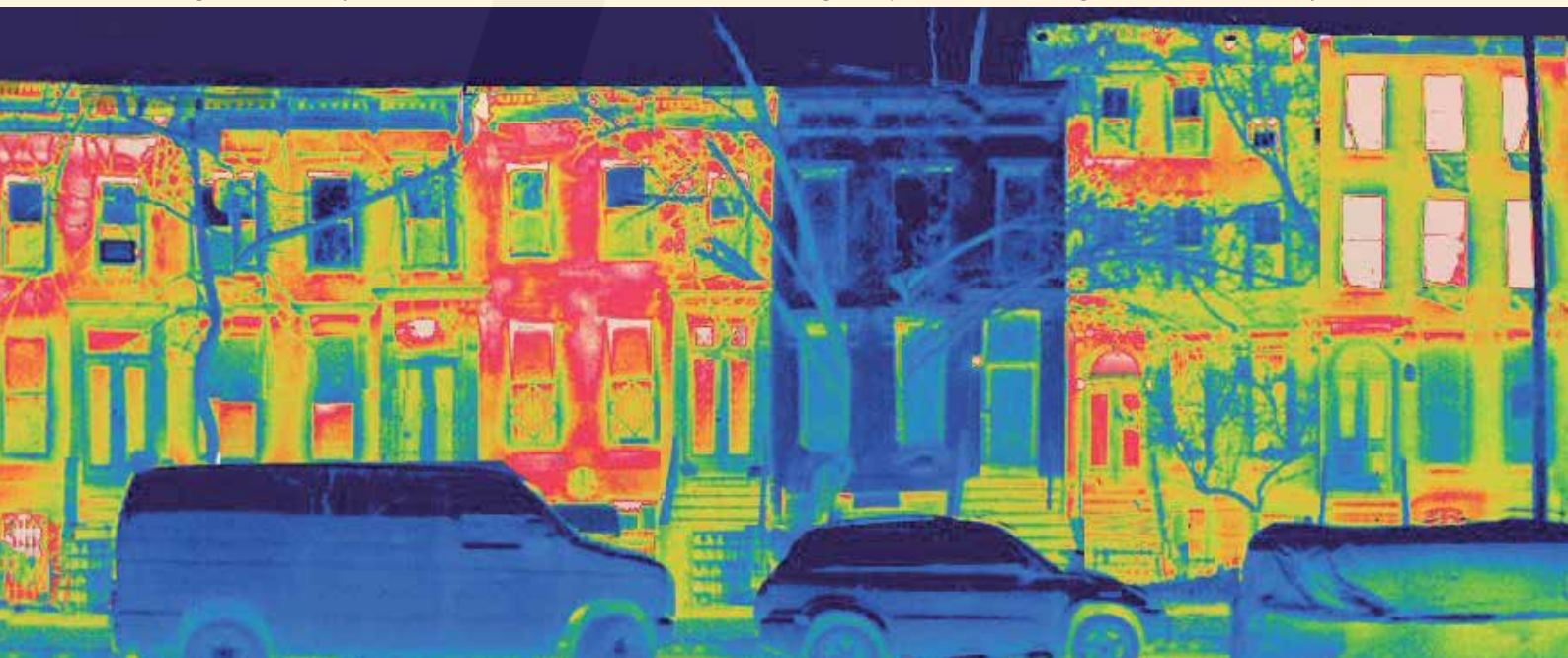

Anything worth doing is worth doing well

Don't settle for less

Whenever a building component needs to be replaced, the materials used and the workmanship involved should be of optimal quality. By using Passive House components for each refurbishment measure, you will arrive, step by step, at an optimum mix of elevated energy efficiency, heightened user satisfaction, and favourable economic results.

Renovation measures can be time and resource intensive, which is why they are typically only carried out when absolutely necessary. So while it frequently makes sense to carry out a complete deep energy retrofit in one go, renovations are more often conducted as the need arises.

In this light, it is important to keep in mind that each part of a building has its own lifespan. While the façade may be crumbling, the roof tiles may still be in great shape. Once the façade has been newly insulated and painted though, it will typically stay that way, for better or worse, for the next 30 to 50 years.

As energy efficiency measures for any one part of a building are always most affordable when that part is already in need of renovation, it stands that anything worth doing is worth doing well. When it is time to refurbish a part of the building, it should be done with an eye to quality and energy efficiency from the start so as to avoid missed opportunities. High quality, deep energy retrofits done to the EnerPHit Standard all in one go may be the best option. When this is not feasible, however, a step by step approach to quality renovation is preferable to mediocre renovations done all at once, as these can compromise any future efforts to achieve low energy consumption.

>> **To find out more** about step by step renovations, have a look at the findings of EuroPHit www.europhit.eu, an EU-funded project on Passive House retrofits conducted over the course of years, also available on Passipedia www.passipedia.org.

“ We have adopted Passivhaus as our core approach, because it enables us to radically reduce energy by design, whilst guaranteeing good comfort. It encourages an integrated approach to design, and because we can rely on it to work, it frees us up to be creative. | Jonathan Hines, Director of Architype, UK

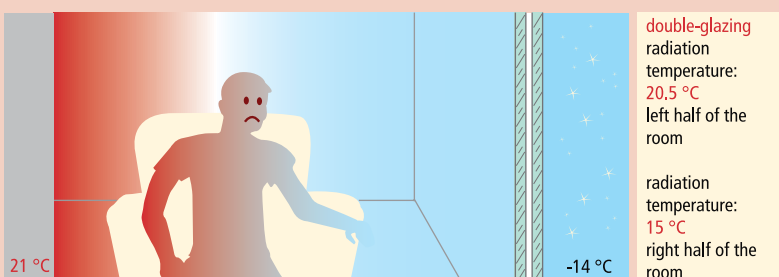
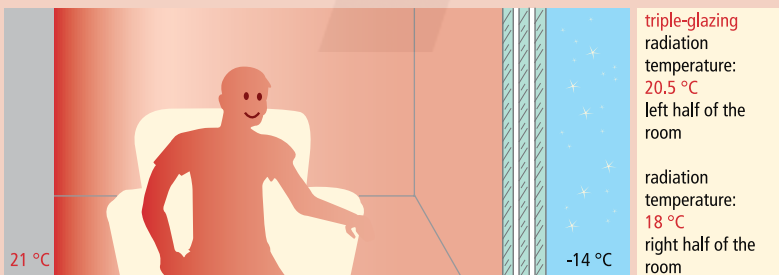

Well-insulated Passive House windows improve comfort dramatically by keeping average inside surface temperatures above 17°C, even in the coldest of outdoor conditions. This, of course, also prevents condensation and mould growth.

The advantages of Passive House components

Saving on energy is only one of the many benefits that come with Passive House, but it is an important one. In conventional buildings, increasing energy prices lead to high running costs and in some cases, fuel poverty. This significant burden, often referred to as “the second rent,” is not an issue in buildings renovated to the EnerPHit Standard. If well-planned and executed, retrofitting to this standard, complete with the installation of Passive House quality components, can contribute to reductions in heating energy consumption of up to 90 percent. In warmer climates, considerable savings in the energy needed for cooling can also be achieved.

That such retrofits considerably improve the substance of existing buildings is perhaps even more significant, for the goal of any renovation is to extend a building’s lifespan and enhance its quality. Excellent insulation levels in combination with effective ventilation systems, for example, virtually eliminate the risk of mould growth. Even in the coldest of weather, Passive House windows are so warm on the inside that condensation does not occur. The living space can then be fully utilised: furniture can be positioned near external walls without fear of mould and areas near windows, now void of radiators and draughts, can be used.

Windows and doors

In many regions of the world, the majority of buildings still have windows with poorly insulating double glazing or even single glazing. Replacing old windows is expensive and it is for this reason that they are not replaced often; new windows should do their job for at least 20 years. The longevity of windows makes it especially important to choose quality products with a view to the future. If windows need to be replaced, well-insulated Passive House windows are the components of choice. For cool temperate climates, this means a window with an insulated frame and triple low-e glazing. In colder climates, quadruple glazing as well as additional optimisation of frame insulation may even be required.

In view of the unavoidable investment costs for new windows, the additional upfront costs for Passive House quality as opposed to conventional double-paned windows is low; the savings they provide in terms of heating and cooling over their lifetimes, however, are substantial.

Thermographic image before (right) and after (left) refurbishment | www.passivehouse-database.org ID 1211 | Faktor 10 | Frankfurt | Germany



Insulation matters

How much is enough?

In cool temperate climates, the economic optimum for external wall and roof insulation currently lies at about 24 cm, assuming a typical thermal conductivity of 0.036 W/(mK). Using insulation thicknesses of 32 cm is equally cost-effective, resulting in even more energy savings and providing even greater independence from energy price volatility. High insulation levels can be seen as an extremely affordable form of insurance against energy price hikes. Of course, applying insulation to the external walls increases their thickness. If the windows are renewed at the same time, they should be fitted in the insulation layer in front of the old window reveal, as this greatly reduces thermal bridging and thus energy losses. This type of installation also has the added benefit that the exterior window reveal depth stays about the same as it was before refurbishment. When additional insulation is applied to an existing façade, the design options are vast. For ornate 19th century façades or classical brickwork, though, it may be better to apply insulation on the inside.

Insulation interior walls

Applying good insulation to the exterior walls is always the best option and it is therefore important to explore every

possibility to do so. In some cases, however, external insulation is simply not possible, such as with historical and listed buildings. Wellplanned and executed interior insulation is certainly better than no insulation at all. In contrast to external insulation, though, interior insulation presents some challenges: it must, for example, be carried out in a very airtight manner and thermal bridging must be reduced as much as possible in order to eliminate cold areas that could lead to moisture damage.

Insulation challenges

In Passive House new builds, insulation can be applied under the floor slab. This is something that is clearly not feasible for existing buildings. An alternative would be to apply insulation above the floor slab and/or use an insulation skirt – external insulation that is applied to the entire exterior wall and that continues down to the foundation. In new builds with basements outside of the thermal envelope (neither heated nor cooled), a thermal barrier is typically built in so that the insulation layer remains continuous. Installing a thermal barrier in existing basement walls to minimise thermal bridges can, however, be rather expensive. As an alternative, flanking insulation can be applied along basement walls that penetrate existing insulation, for example, where they join the basement ceiling.

Old situation: Cold surface temperatures can lead to humidity-related damage

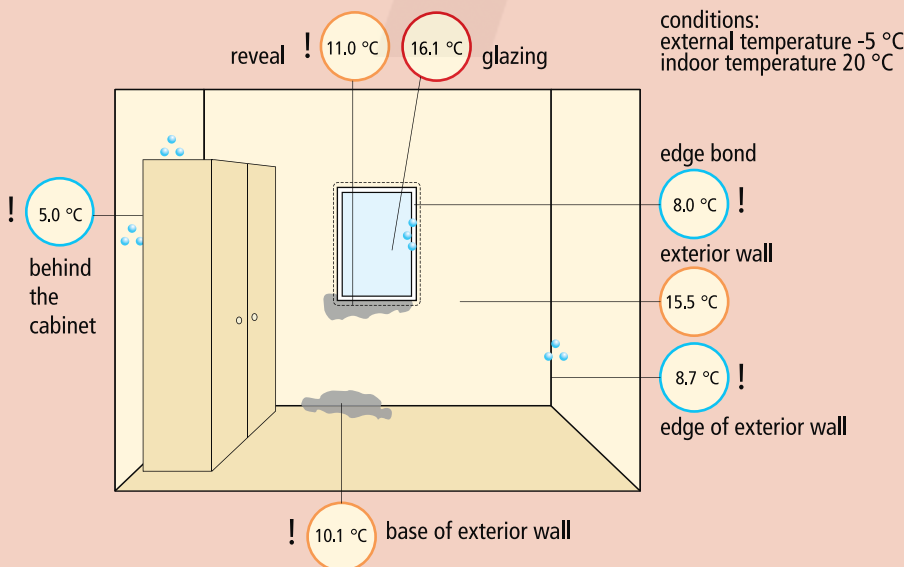

Before a deep retrofit: Cold surface temperatures can lead to moisture-related damage.

The walls of older buildings are usually poorly insulated. The temperatures of the interior surfaces drop in cold conditions and humidity levels rise, often so much so that mould growth occurs. Good exterior insulation can prevent this from happening.

This helps reduce energy losses through thermal bridges while raising the interior surface temperatures of the rooms above.

Achieving airtightness in retrofits

The interior plaster can provide an airtight seal in buildings with concrete ceilings if damages are repaired and the plaster is directly adjoined to the unfinished floor. It is more difficult to guarantee continuous airtightness in timber beam ceilings due to the joist connections to the external wall. If insulation is applied to the façade, it may be expedient to apply the necessary adhesive evenly over the entire surface in order to create an airtight layer at the level of the original external wall covering.

On the roof or the uppermost ceiling, the vapour barrier sheet, necessary to keep the building damage free, can also serve as the airtight layer. Depending on the position of the insulation, the basement ceiling or reinforced concrete floor slab may form the lower boundary of the building. If the basement ceiling is not airtight, a crack free screed could serve as the airtight layer. New windows can be equipped with a plastered-in sealing sleeve.

Airtightness, insulation and mould growth

External insulation is the best way to prevent mould growth in cold conditions as it increases temperatures on the inner surfaces of the walls, roof, and basement ceiling. Condensation is thus prevented on interior surfaces and greatly reduced at any remaining thermal bridges. This is extremely important, for mould thrives in the wet conditions resulting from condensate. Increased surface temperatures therefore not only perceptibly improve comfort, they also drastically reduce the risk of mould growth. Airtightness also does its part by diminishing energy transfer through the walls while protecting the building from moisture damage due to the passing of warm, damp air. Well-insulated, airtight buildings as well as energy retrofits should, however, include the installation of a ventilation system to prevent excessive moisture accumulation in the air and on the surfaces of building elements.

>> Further information on Passive House refurbishment of older buildings can be found on Passipedia, www.passipedia.org.

New situation: Refurbished with Passive House components

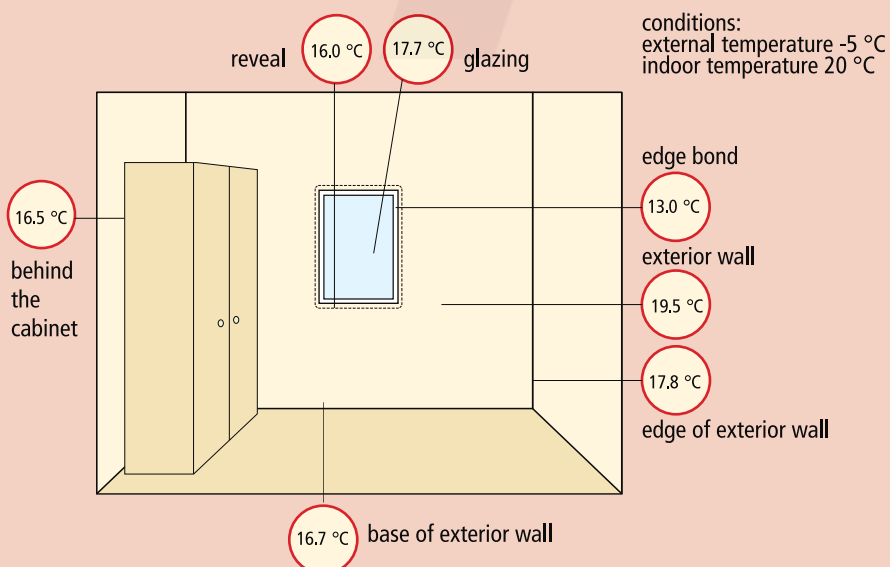

After a deep retrofit: Refurbishment with Passive House components prevents humidity-related damage.

The same living room after renovation with 200 mm of external insulation and Passive House windows. On a cold winter day, almost all surface temperatures remain above 16°C. This is even true at the skirting board and in the corner behind the cabinet. The moisture level remains low so that there is no risk of mould growth.

A breath of fresh air

Proper ventilation

Good ventilation systems transport unpleasant odours, moisture, and polluted air out of the building while ensuring consistently good air quality, thereby improving health and preventing building damage. Measurements confirm that good air can hardly be achieved with manual ventilation via the windows alone: to match the air quality that a ventilation system can provide, a building's windows would have to be opened completely, once every four hours, until the air in each room is replaced entirely.

In most areas of the world, Passive House ventilation means ventilation systems with heat recovery. When properly installed, such systems can save more than 10 times the energy they require for operation. These systems are also quite small, meaning they can be conveniently placed in a storage room. As space is often at a premium in retrofits, flat devices are also available that can be integrated into a suspended ceiling or wall. Such ventilation systems can be installed in either a centralised or decentralised fashion. In any case, the installation of at least a simple exhaust air system (without heat recovery) is a minimum requirement for hygienic reasons.

The extra expense incurred by an energy efficient heat recovery ventilation system, however, will often pay off due to the additional energy savings.

Airflow through doors

For the ventilation system to function properly, airflow from room to room needs to be ensured, even when doors are shut. If this is not already the case, interior doors can be shortened to allow for a gap of at least 10 mm above the floor. Alternatively, interior doors may be fitted with air vents.

Old heating systems put to good use

Old heaters and pipes can often still be used after an energy retrofit. Since less heating power is needed after such renovations, the water in a water-based radiator system, for example, can be kept at a lower temperature so that the heating system may work more efficiently. In most cases, the boiler itself is then too large and can be replaced by a smaller, more efficient version.

Replacing the filter of a ventilation unit.



Planning step by step retrofits

In deep energy retrofits, it is always best to begin with the building element most in need of replacement. Replacing building elements that will still be useful for a long time to come, simply in order to improve the energy balance of the building, may not always prove economical. There may, nonetheless, still be good arguments to replace them, for example, for reasons of comfort or to prevent structural damage. Each retrofitting measure undertaken should be carried out with an eye to ensuring the best possible conditions for later improvements. If, for example, the roof is being renewed and insulated, the roof overhang should also be extended so that it will provide enough space for the installation of an appropriate level of external insulation in a later step.

Improved insulation or a renewal of the heating system?

Consistent renovation with Passive House components results in lowered heating and cooling demands as well as peak loads. Existing systems are then over-dimensioned for the needs of

the refurbished building. If the heating and/or cooling systems are not in urgent need of replacement, it is typically most cost-effective to begin with the optimisation of the building envelope and the installation of a ventilation system. The heating and cooling systems can then be economically replaced at a later date with smaller power units that better conform to the new, reduced level of need.

If, on the other hand, the heating or cooling system is defective and must be replaced first, the installation of the most efficient system possible is essential. This can, for example, be in the form of a condensing boiler with low standby losses that will still produce heat efficiently once the building envelope has been improved.

Living with construction?

Careful planning reduces the time required for the installation of the ventilation system to four or five days, and to one day for the fitting the windows. During this time there may be some inconvenience, but occupants can generally remain in the building.

Whenever refurbishment measures become necessary, the most efficient systems must always be applied because they will help determine the building's energy requirements for the next 20 to 50 years. | Dr. Wolfgang Feist, Passive House Institute

Ventilation unit with heat exchanger exposed



Supply air ducts with sound absorbers during installation



Efficiency – the key to green building

Reducing demand

Good insulation, highly efficient windows, a ventilation system with heat or energy recovery, and an airtight building envelope are sure ways to reduce heating and cooling needs. The Passive House concept makes optimal use of these elements: whereas heating and cooling can account for more than 80 percent of the total energy demand in existing buildings, heating and cooling a Passive House requires no more energy than that which is needed for domestic hot water.

With such low energy needs for heating and cooling, other aspects that typically only make up a small percentage of total energy use begin to take on more significance. Hot water production, for example, makes for a substantial part of the total energy use in a Passive House. Water-saving fixtures for showers and sinks can lead to significant reductions in hot water demands and translate directly to energy savings. In cold regions, where heating needs are high, waste water heat recovery devices may also be useful.

Electricity typically makes up the largest share of total energy use in Passive Houses. By complementing optimised use of daylight with LEDs, which use much less energy than conventional

“low-energy” light bulbs, energy savings can be achieved in an especially cost-effective way. Improved light quality, instantaneous light, and longer bulb lifespans are additional benefits of LED technology. Energy efficient IT and communications devices can also help cut electricity use significantly: contemporary laptops require 75 percent less energy than standard desktop computers. These savings can be doubled by using tablet computers. When it comes to refrigerators, freezers, dish washers and washing machines, buying the most efficient devices pays off: any additional costs are usually compensated by the energy saved during their use.

Efficiency first

In a Passive House building, efficiency clearly comes first, and with good reason. Efficiency stands as an unproblematic “source” of energy since energy that isn’t used in the first place doesn’t need to be generated. Reducing our overall energy consumption will allow us to use the sources available in a sustainable and affordable way while curbing the impact of energy price hikes and safeguarding social, economic, and environmental welfare.



Energy supply options

Passive House makes it feasible to cover building energy demand with a wide variety of energy sources, but how sustainable are the options we have available?

Fossil fuels such as coal, crude oil, and natural gas cannot be the basis of a sustainable energy supply, both because they are finite resources and because the carbon dioxide they emit drives climate change. Nuclear energy poses a threat to our environment at every stage of its lifecycle, from the extraction and enhancement of uranium, to the running of the plants, through to the disposal of radioactive waste. Deep geothermal energy is a borderline case: the heat contained within the earth's interior is practically inexhaustible but its use as an energy source is not without problems. The drilling of deep holes as well as active injection of water under high pressures can result in seismic activity and, in turn, lead to structural damage in buildings. Additionally, the soil around the extraction site eventually cools down, meaning that the original source will "run dry."

Near-surface geothermal energy, on the other hand, as in the use of environmental heat through heat pumps, for example,

does not tap the earth's heat but makes use of solar energy stored within the top layers of the soil. In winter, the heat pump extracts heat stored in the soil, thereby cooling the soil down. As warmer conditions return, the soil is again heated by the sun and any summer rains. Used correctly, this "energy source," just like the sun itself, is inexhaustible over human time scales.

The use of biomass has its challenges and must be evaluated carefully: making use of residual material such as left-over wood, straw, or other agricultural wastes can be sustainable. Using biomass in material recycling is even more effective: building a wooden house insulated with recycled paper is better than burning wood and paper to heat an uninsulated house. Competition with food production must, however, be avoided and it is important to note that, over human time scales, energy from biomass is also limited.

Solar arrays on roofs or façades have a definite role to play in a sustainable energy mix as the sun's energy is practically infinite. The same holds true for wind energy. Provided that the systems and schemes used to harvest such renewable energy are produced and planned as sustainably as possible, the environmental and social impacts remain low.

Certified single family house | www.passivehouse-database.org ID 1125 | karawitz architecture | Bessancourt | France



LED lights should have an efficiency value 65 lm/W or greater and a colour rendering index (CRI) of at least 80.



Passive House and renewables – a perfect combination!

Bridging the winter gap

Completely covering our energy demands with renewables is a great challenge, especially in those parts of the world where much heating is required. In regions such as Northern and Central Europe, North America, as well as large parts of northern Asia, most energy is used during the winter months. Low temperatures result in higher heating demands while the lack of daylight requires more artificial lighting. At the same time, solar energy is less abundant and hydroelectric output decreases as rainfall turns into snow. Even though cold days often come with stronger winds, these do not nearly make up for the lack of sun and water power in the face of increased heating needs.

An emphasis on the use of renewables to power our building sector can thus only be sustainable if we focus on reducing our energy use first. Passive House does just that: the extreme levels of energy efficiency reached by Passive House buildings means that their minimal remaining energy demand can be covered economically by a wide variety of stable and sustainable energy sources. A bias towards renewables, on the other hand, may result in a cumulated “net zero” or “energy plus” building, but will do little to bridge the winter gap.

Cooling and renewable sources

In warm climates where cooling demands dominate, a purely renewable energy supply is much easier to achieve. Hot days with high peak cooling loads typically come with plentiful sunshine. In this case, energy generation and energy use match up well; photovoltaic systems can capture the sun’s energy so that it can be used for cooling via electric heat pumps. This constellation results in negligible storage requirements and inexpensive energy supplies.

Adding a “plus” to Passive House

Energy efficient design is constantly evolving, with new building concepts being presented every day. Net zero or energy plus concepts, often based on the extensive use of rooftop solar energy systems, are meant to turn homes into small power stations.

Such buildings, however, can only truly be self-sufficient if their energy demand is extremely low. Once this is the case, using renewables to cover energy needs for heating, cooling, dehumid-ification, hot water, ventilation, and electricity becomes much easier.

Plus energy: this approach often requires large surface areas if buildings aren’t extremely energy efficient.

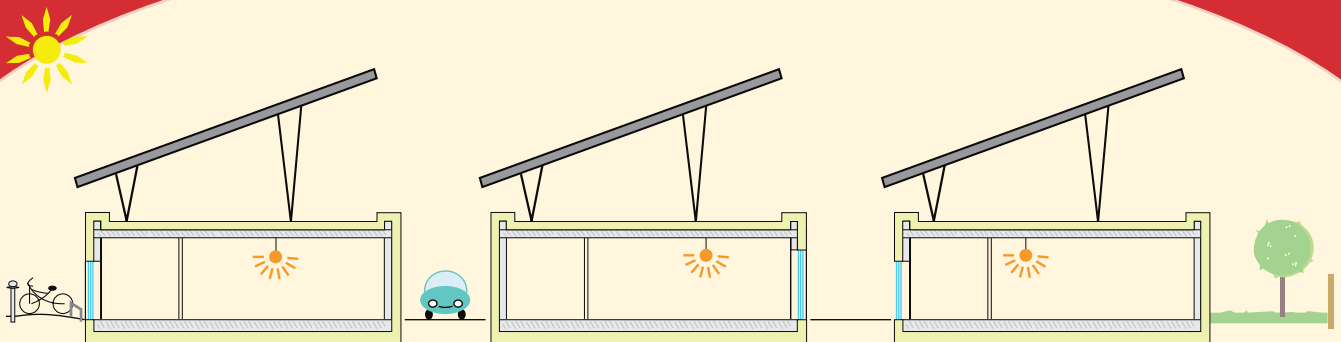

Passive House, with its focus on efficiency, thus stands as the ideal basis for all such energy concepts, both present and future. Neglecting efficiency and focusing solely on renewables inevitably leads to higher energy costs along with either larger investments in photovoltaic and/or wind power systems, or the need to add fossil fuels to the energy mix.

A straightforward approach

On cold, sunless winter days, even large photovoltaic systems will fail to produce enough energy to make up for the losses incurred by an uninsulated roof. Future proofing your roof therefore means insulating it first and adding photovoltaics second. In cold regions, this order is decisive in bridging the winter gap.

In warmer regions that require cooling, insulation finished with a coat of cool coloured paint will also result in reduced energy needs, lessening the roof space required for solar panels that can power your building. The remaining space can then be used for other purposes or for the production of additional electricity to power an electric car, for example.

The efficient use of scarce resources is an underlining principle of sustainability and this includes land use. Buildings with fewer storeys and larger roof areas may provide more space for photovoltaic arrays, yet such buildings are by no means more sustainable than compact ones. Due to their disproportionately large surface areas, small, single-storey buildings require a larger share of the land as well as more building and insulation material.

Intelligent building concepts are therefore based on compact design and superior efficiency, as this allows renewable energy systems to be smaller, less complex to connect to the grid, and, as a result, much more affordable.

The smartest way to build or refurbish a building is to aim for Passive House efficiency first. This can then be complemented by photovoltaic systems on roof and potentially other surfaces that face the equator and are exposed to direct sunlight. This approach offers an ideal combination of Passive House principles and renewable energies. It is the surest way towards zero or even plus energy, resulting in buildings fit for the future, especially in light of trends towards tighter energy legislation in many countries and regions worldwide.

Passive House Plus: highly efficient buildings require smaller photovoltaic systems resulting in sustainable housing and reduced land use.

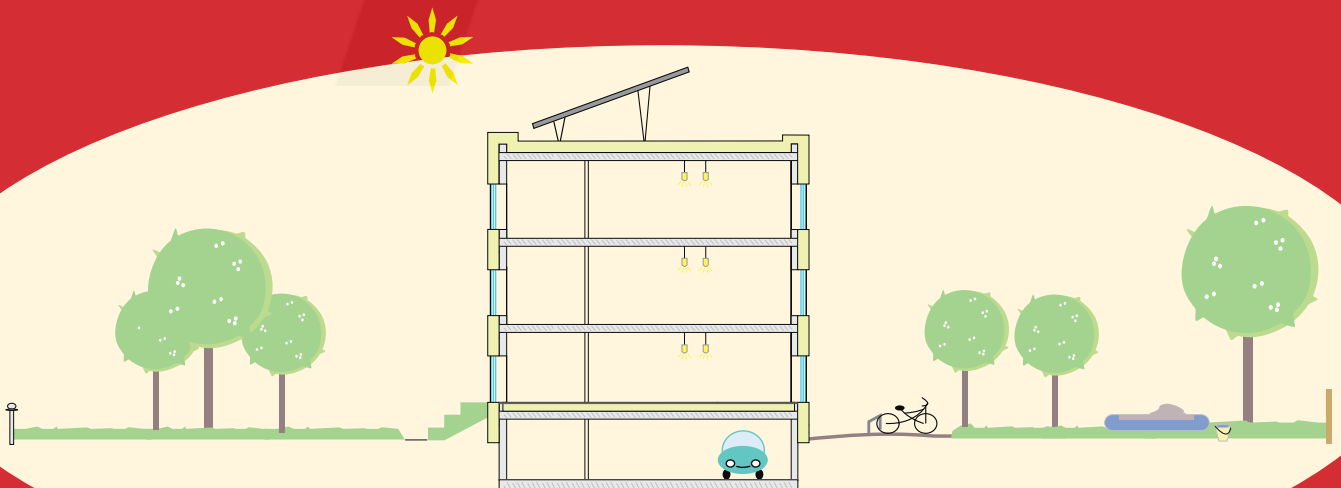

Maximum benefit, minimal cost

Passive House means energy savings

With good design, an experienced team, and readily available components, Passive House stands as an economically attractive option in almost all reaches of the globe (see the Passive House Institute study, "Passive Houses for Different Climate Zones"). While the total investment costs are often somewhat higher due to the necessity of better quality products and more detailed planning, this is not always the case: many Passive House buildings have been built at costs comparable to or even under those for similar conventional buildings.

Passive House guarantees extremely low costs for heating and cooling. When taking capital costs and running costs into account, this fact generally means that Passive Houses cost less over their lifecycles than their conventional counterparts. Factors influencing this cost balance include not only the skill of the design team, but also construction prices, interest rates, available financial incentives, future energy prices, and even individual client wishes (as in any building, energy efficient or not). The increasing availability and decreasing costs of suitable components combined with the growing numbers of experienced designers and craftspeople are making the cost balance for Passive Houses ever more favourable.

1. Optimal Insulation

The level of insulation required for Passive Houses depends on a variety of factors such as the climate, the building's shape, and its orientation. Even the quality of other building elements plays a role: using extremely good windows, for example, may mean that lower levels of insulation are needed. Nonetheless, Passive House levels of insulation are almost always higher than those required by building codes. With the prices for scaffolding and labour remaining unchanged, the extra insulation costs are insignificant by comparison. Given the energy savings it brings, investing in thicker insulation pays off from the very beginning, even at today's energy prices.

2. Airtight building envelope

Improving a building's airtightness helps prevent structural damage and increases the level of comfort. When done from the start, airtightness is also perhaps the most cost-effective energy efficiency measure. Making up for poor airtightness at a later stage always ends up being more complex and thus more expensive than using careful construction methods from the very outset. Airtightness done well brings no additional costs. On the contrary, an airtight envelope helps prevent potential repair costs.

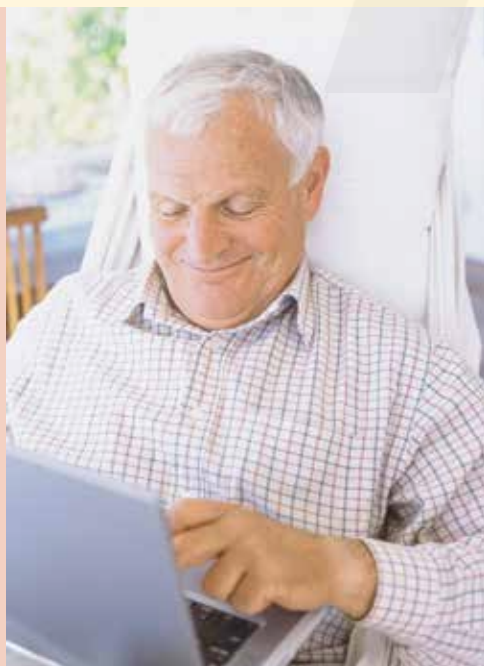

Reducing energy consumption, investing in added value

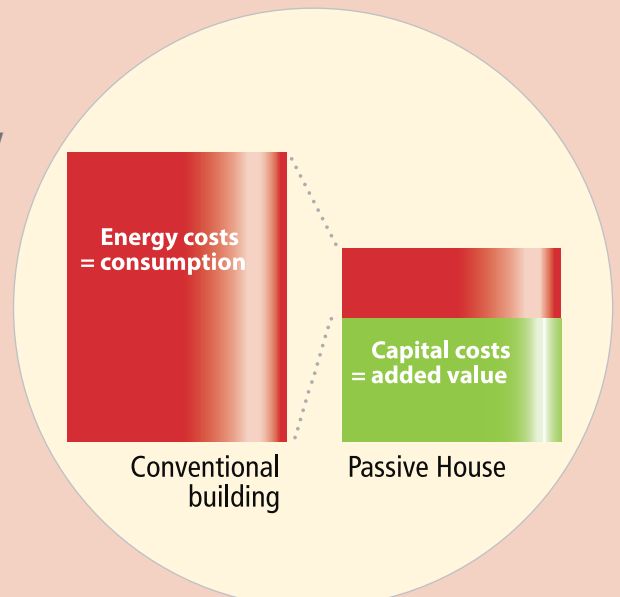

3. Thermal bridge free building envelope

Small and mid-sized Passive Houses should be designed so that they are free of thermal bridges. With experienced architects, this design feature comes at almost no additional cost. In larger buildings, completely avoiding thermal bridges, especially for load-bearing construction elements, may be more difficult. The large volume to surface area ratios of such buildings, however, result in fewer energy losses and make a certain amount of thermal bridging acceptable. Somewhat better insulation of other parts of the façade can also help make up for these thermal bridges. On the whole, the cost-benefit ratio for thermal bridge reduction is excellent.

4. Passive House windows

Passive House windows must fulfil demanding requirements. Fortunately, there are many products available on the market today that do. Better quality has its price of course. Yet Passive House windows are indispensable for reasons of both efficiency and comfort. Thanks to their lower energy losses, heating and cooling costs are reduced. As an additional benefit, these windows greatly enhance comfort by maintaining room temperatures near their surfaces. The investment in quality Passive House windows is definitely worthwhile.

5. Heat recovery ventilation system

In energy efficient buildings, ventilation systems are essential for good health, as they ensure appropriate amounts of clean, fresh air while hampering moisture build-up and mould growth. Ventilation systems should thus be installed in every new build and energy retrofit. The reduced levels of indoor air pollution are reason enough to invest in a good ventilation system. The costs of such systems, indeed, result in extra construction expenses. In most climates, ensuring that the system comes with highly efficient heat recovery means that some of these investment costs can be regained in the form of energy savings throughout the building lifecycle.

6. Saving on your investment

A Passive House requires much less energy for heating and cooling. This means that smaller, more affordable heating and cooling systems can be employed. In Passive Houses, radiators also don't need to be positioned at the external walls, resulting in shorter, thinner, and generally simplified distribution systems. Chimneys, fuel tanks, and tank rooms are often no longer necessary. These savings, in conjunction with good planning, can make up for much of the extra investments required to achieve the Passive House Standard.

Artist Studio | www.passivehouse-database.org ID 2827 | Ryall Porter Sheridan Architects | Orient, New York | USA



Quality is fundamental

Careful planning

In order for a Passive House to perform as designed, quality needs to be prioritised at every step of the planning and construction process. Building certification helps ensure that a building owner gets what has been promised. Certified Passive House Designers and Consultants have the knowledge necessary to ensure quality in the lead-up to building certification. At the basis of all of this, however, lies the Passive House Planning Package (PHPP).

The PHPP

PHPP



A product of over 15 years of research and development, the PHPP is the energy balance design tool for the planning of Passive Houses and other highly efficient buildings. Excel-based, the PHPP makes use of tested algorithms to yield a building's heating, cooling, and primary energy demand, a building's heating and cooling loads, its tendency to overheat, and much more. This powerful tool can also be used to dimension ventilation systems and determine the energetic effects of the substitution of any product or of any design change. The PHPP produces highly accurate results, as proven on thousands of projects. It both facilitates planning and serves as proof that the Passive House or EnerPHit Standards have been met.

PHPP versions 8 and above also allow for 3-D data entry with the new designPH SketchUp plugin.



Certified building components

Certified Passive House Components offer further security in the design of highly efficient buildings. Certified by the Passive House Institute, these products have been thoroughly examined in terms of their energetic performance. There are three categories of certified Passive House Components:

- **Opaque building envelope**
(Construction and insulation systems | Connections)
- **Transparent building envelope**
(Glazing | Windows | Doors)
- **Mechanical systems**
(Ventilation units | Heat pumps | Compact units)



Today, designers can choose from hundreds of Certified Passive House Components manufactured by a large variety of companies in ever more countries worldwide. All certified components, complete with certificates, efficiency classes, and special product features, are visible on the Component Database under the certification section of www.passivehouse.com.

Passive House duplex with solar heated pool | www.passivehouse-database.org ID 3881 | László Szekér | Budapest | Hungary



Passive House user experiences

Easy comfort

For some, comfort is the most attractive aspect a Passive House has to offer. It stands to reason, then, that comfort has played a large role in studies dating from the very first Passive House built in the early 1990s until today.

When questioned about their experiences, Passive House occupants are often overwhelmingly positive. Indeed, in multiple studies on terraced housing estates and multi-storey buildings, Passive Houses consistently performed extremely well. This proves that Passive House residents are neither eco-warriors nor miserly penny-pinchers willing to suffer through uncomfortable conditions just for the sake of saving energy: Passive House offers comfort through pleasant temperatures and plentiful fresh air as well as structural longevity, alongside dramatic energy savings.

Most Passive House residents feel that life in a Passive House is completely normal. There are some differences, of course:



“Living here is much easier, the maintenance of the building is much simpler, you don’t have to worry about boilers, fuel tanks, radiators, etc.” | Gabriel and Eva, residents of a Passive House in Granada, Spain

Hotel | Arch. Nicola Alberti-Armalab | www.passivehouse-database.org ID 2521 | Nago Torbole, Lake Garda | Italy

“Our greatest satisfaction in having built a Passive House hotel comes from our customers’ smiles – happy to have had the chance to stay in a building that cares for those who inhabit it. Now that is pure energy!” | Klaus Arrigo Jacobitti and Elisabetta Marinelli, investors and owners of the Bonapace Hotel, Lake Garda, Italy





PASSIVE HOUSE PROJECTS



Project reports – the 2014 Passive House Award winners

- 50 The 2014 Passive House Award
- 52 Project 1 – Office and special use buildings
- 54 Project 2 – Educational buildings
- 56 Project 3 – Apartment buildings
- 58 Project 4 – Single family homes | terraced
- 60 Project 5 – Single family homes | detached
- 62 Project 6 – Retrofits





The Award

A celebration of architecture, the 2014 Passive House Award demonstrates the great potential and versatility offered by Passive House solutions. Its purpose: to acknowledge Certified Passive House Buildings distinguished by outstanding architectural design.

Over 100 projects were submitted for the 2014 award, which was carried out under the patronage of the German Federal Ministry for Economic Affairs and Energy. Additional support came from the European Union in the framework of the PassREg project. A total of 21 finalists were initially selected by the award jury, each deserving of an award in their own right. From these, seven winners spread over six categories, five for individual buildings projects and one for Passive House regions, were finally chosen.

The Categories

- Regions (through PassREg)
- Office and special use buildings
- Educational buildings
- Apartment buildings
- Single family homes
- Retrofits

Coming from a total of 21 different countries, the submissions to the 2014 Passive House Award were clearly international. This internationality is also reflected in the variety of winning projects, presented on 25 April 2014 at the International Passive House Conference 2014 in Aachen, Germany. The six individual buildings project winners are detailed in the following pages.

With special thanks to our sponsors

Munster Joinery
Pro Clima
ABG Frankfurt Holding
Saint Gobain

Supported by:



Federal Ministry
for Economic Affairs
and Energy

on the basis of a decision
by the German Bundestag



Co-funded by the Intelligent Energy Europe
Programme of the European Union



The Winners

Numerous examples of excellent architecture, underpinned by the Passive House Standard, can be seen worldwide. The winners of the 2014 Passive House Award illustrate just how beautiful extremely energy efficient buildings can be. A pre-requisite for all project submissions was Passive House certification (or EnerPHit certification for retrofits), according to the internationally recognised criteria set out by the Passive House Institute. This solid basis allowed the jury to focus solely on architectural design during their assessment.

In the award-winning buildings featured on the following pages, energy efficiency and high-level architecture go hand in hand. The first art museum built to the Passive House Standard is already a major attraction in the midst of the historical centre of German Ravensburg. In South Korea, a new seminar and apartment building blends beautifully into the surrounding mountain landscape while a seven-storey apartment complex in Berlin, completed by a multi-generation community, boasts its zero-emission credentials. In Philadelphia, a terraced social housing development shows just how cost-effective Passive House buildings can be while another social housing project, emerging as an ensemble of single family homes, reaches the Passive House Standard despite Finland's harsh climate. Finally, a 114 year-old inner-city brownstone undergoes a surprising transformation to Passive House level in a New York energy retrofit.

These winners are a mere sampling of what is possible with Passive House.

The Jury

The members of the 2014 Passive House Award jury (photo below, from left to right):

Mark Elton

Sustainable By Design | UK

Raimund Rainer

Architect Raimund Rainer | Austria

Ludwig Rongen

Rongen Architekten | Germany

Robert Hastings

Architecture, Energy & Environment (AEU) | Switzerland

Wolfgang Feist

Passive House Institute | Germany and Austria

Zdravko Genchev

Eneffect | Bulgaria

Helmut Krapmeier

Energieinstitut Vorarlberg | Austria

Jeroen Poppe

Passiefhuis-Platform (php) | Belgium

Burkhard Fröhlich

DBZ Deutsche BauZeitschrift | Germany

www.passivehouse-award.org



Office and special use buildings

Kunstmuseum Ravensburg | Ravensburg | Germany

A prominent theme in the design of the Ravensburg Art Museum was that of continuity. How do you ensure that a new build fits in with its historical surroundings? The museum was not to stand as a stark contrast with a very modern design, nor was it to be made to look centuries old. The aim was not to design an eye-catcher, but a building with subtle aesthetics, turning heads only upon second glance.

Architects like Lewerentz or Döllgast have addressed this problem in the past with fascinating workmanship, familiar materials, beautiful construction, and efficient floor plans. This was the inspiration for the simple spatial concept: a courtyard and neutral, rectangular exhibition areas, encircled by access points and clad with a recycled brick façade. Similarly, the vaulted roof is also clad with a brick shell.

With Passive House, the consideration of thermal bridging is crucial when designing the building envelope. The building foundation consists of concrete piles supporting the garage ceiling, without thermal breaks. The heat flow was reduced by using 26 cm thick insulation on the garage ceiling as well as additional insulation flanking the piles. The cavity walls are

filled with 24 cm of insulation. The wall ties had to achieve maximum performance in terms of stability whilst minimising thermal bridge losses. Newly developed ties with a reduced steel content and lower thermal conductivity were thus used.

The building's vaulted roof also received 30 cm of insulation. The parapet thermal bridge was reduced by covering it with insulation and via decoupling, so that the façade and roof insulation form a continuous layer. The transparent components consistently meet the Passive House criteria, with the exception of the revolving door. This was the first time a revolving door was used in a Certified Passive House and it was optimised in terms of both insulation and airtightness. Multiple glazing was used along with thermally broken profiles and double brush seals. The building envelope concept proved viable, receiving an airtightness value of only $n_{50} = 0.30/h$.

The art museum has a ventilation system with both heat and moisture recovery. The building is heated by a 40 cm thick concrete core ceiling, supplied by deep borehole heat exchangers and a gas absorption heat pump. This system is reversible and can also be efficiently used for cooling.

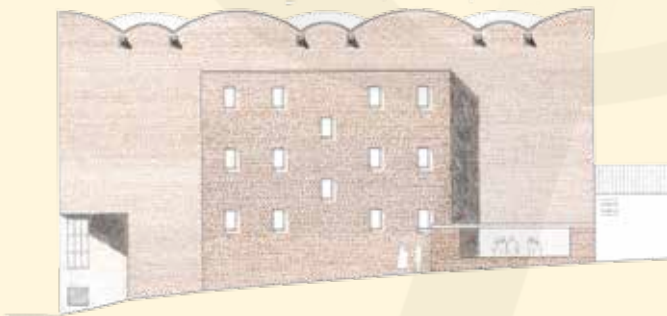

section

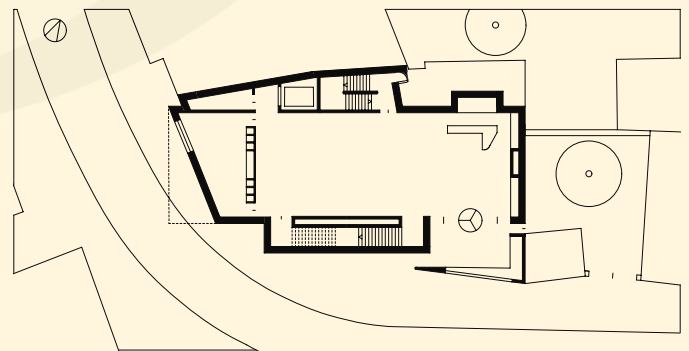

first floor plan

Project information

 Certified Passive House | Museum
New build | Ravensburg | Germany
Treated floor area according to PHPP: 1288 m²
Year of construction: 2012
Project database: ID 2951

Architects

Lederer Ragnarsdóttir Oei Architekten
www.archlro.de
 Certified Passive House Designer

Photos

Roland Halbe

Build-ups | Masonry construction

External wall [U-value: 0.14 W/(m²K)]
Reinforced concrete | 24 cm mineral wool | brick
Roof (vaulted) [U-value: 0.13 W/(m²K)]
Exposed brick | reinforced concrete | sealing | 30 cm mineral wool | sealing
Staircase ceiling [U-value: 0.14 W/(m²K)]
Reinforced concrete | sealing | 28 cm mineral wool | sealing
Ground floor/underground garage ceiling [U-value: 0.14 W/(m²K)]
Reinforced concrete | 26 cm flanking insulation

Airtightness of building

$n_{50} = 0.30/h$



Windows

Frames [U-value, installed = 1.04 W/(m²K)]

Timber profiles | post-and-beam construction | fixed frame | tilt and swing | revolving door | skylights | dome lights | smoke and heat ventilation flaps

Glazing for roof light and revolving door [U-value = 1.1 W/(m²K) | g-value = 54 and 18%] | Safety glass

Remaining glazing [U-values = 0.74, 0.65, and 0.54 W/(m²K) | g-values = 45 and 49%] | Triple glazing with low-e-coating and argon filling

Mechanical systems

Ventilation and frost protection

Plate heat exchanger (heat only) | subsoil heat exchanger (brine)

Heating: Water source heat pump

Domestic hot water: Direct electric

Cooling and dehumidification

Ground coupled hydronic passive cooling | adsorption dehumidifier

Heating demand (according to PHPP)

15 kWh/(m²a)

Heating load (according to PHPP)

13 W/m²

Cooling demand (according to PHPP)

none

Cooling load

4 W/m²

Primary energy demand

(according to PHPP, including total electricity demand)

122 kWh/(m²a)



Educational buildings

Seminar and apartment building | Goesan | Republic of Korea

This seminar and apartment building is an extension of the existing training academy of Korean food manufacturers Pulmuone Health & Living Co. The company's desire to build in an environmentally friendly way is very much in line with its focus on sustainable farming and healthy food.

The building is situated on the edge of a nature reserve, at a significant distance from the existing academy. It uses its position in this natural landscape well, taking full advantage of the topography. Thanks to its free-flowing forms, an ancestral grave was preserved in its original surroundings.

The building hosts a seminar wing with several classrooms and a kitchen area. The rooms are connected by a spacious entrance hall and lobby. Guest apartments, in the form of both single and shared rooms with individual bathrooms, are located in another wing. Large, open areas on the first floor and in the gallery serve as common spaces.

The design is sculptural in nature with variety of free forms – a reflection of the building's backdrop, which is characterised by terraced rice paddies along the slopes and trees covering rolling hills, punctuated by meadows with gravel fields. Developed in multiple levels, the green roof forms a bridge with the wild landscape and harbours accessible foot-paths leading into the wilderness.

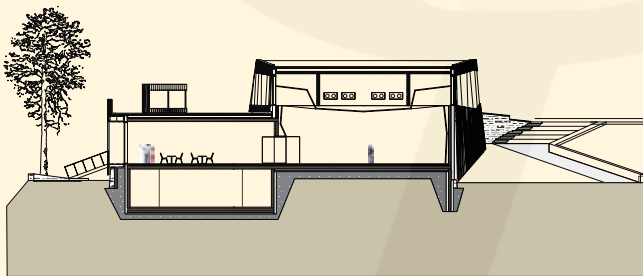

section

Curved forms remain a key theme within the building itself. All throughout the interior, visual reminders of the building's outdoor surroundings abound. Direct access to the outdoors is built into every section and level of the building. The individual rooms and auditoriums within form independent structures, connected to one another by open spaces.

The building materials and surfaces are dominated by natural materials including wood, stone, and clay. This borrows directly from construction materials typically found in traditional Korean architecture.

The energy concept, designed according to the Passive House Standard, provides a high level of comfort during Korea's cold winters and hot, humid summers. The building's mechanical systems are optimised for the climatic conditions, supporting both cooling and dehumidification.

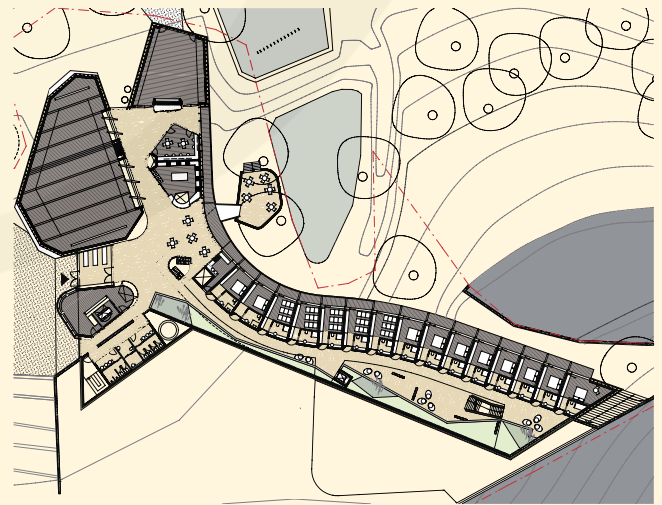



site plan

Project information

 Certified Passive House | Training facility
New build | Goesan | Republic of Korea
Treated floor area according to PHPP: 2452 m²
Year of construction: 2012
Project database: ID 2957

Architects

ArchitekturWerkstatt Vallentin, Gernot Vallentin
www.vallentin-architektur.de
 Member of the International Passive House Association (iPHA)
 Certified Passive House Designer

Photos

YOON-BOUM, CHO Dipl.-Ing. Architekt

Build-ups | Mixed construction (timber and masonry)

External wall [U-value: 0.14 W/(m²K)]
Sarking board | 32 cm cellulose insulation between wall studs | reinforced concrete | clay plaster
Roof [U-value: 0.09 W/(m²K)]
Soil | drainboard | concrete | sealing | 30 cm polyurethane insulation | reinforced concrete | clay plaster
Floor slab [U-value: 0.12 W/(m²K)]
Blinding | 24 cm XPS perimeter insulation | reinforced concrete | impact sound insulation | screed | floor covering

Airtightness of building

$n_{50} = 0.17/h$



Windows

Frames [U-value_{installed} = 0.90 W/(m²K)]

Timber profiles with aluminium cover strip | post-and-beam construction

Glazing [U-value = 0.70 W/(m²K) | g-value = 50%]

Triple glazing with low-e-coating and argon filling

Mechanical systems

Ventilation and frost protection

Plate heat exchanger (heat only) | hydraulic pre-heater

Heating

Solar thermal (45%) | water source heat pump | floor heating

Domestic Hot Water

Thermal solar collectors with 12,000 litres of storage | on-demand geothermal water heating

Cooling and dehumidification

ground coupled hydronic passive cooling | refrigerative dehumidifier in supply air

Heating demand (according to PHPP)

8 kWh/(m²a)

Heating load (according to PHPP)

9 W/m²

Cooling demand (according to PHPP)

15 kWh/(m²a)

Cooling load (according to PHPP)

10 W/m²

Primary energy demand

(according to PHPP, including total electricity demand)

119 kWh/(m²a)



Apartment buildings

Boyen Street zero-emission apartments | Berlin | Germany

The Boyen Street zero-emission apartments stand as the first seven storey zero-emission residential building in Berlin. Completed in May 2013 by a multi-generation property owner community, the building contains 21 residential units and is located on the edge of Berlin's government district.

The project demonstrates how the energy revolution can be implemented via the housing sector: the complex generates zero CO₂ emissions and even has a positive annual energy balance, made possible by a mix of Passive House and energy production technology. The semi-central ventilation system boasts a heat exchange with 85% efficiency while photovoltaics and onsite combined heat and power help generate the needed energy.

Within the building, heating is conducted principally via the supply air, which utilises geothermal energy from underground loops for frost protection. The only radiators present are the heated towel rails located in each bathroom purely for the purpose of added comfort. Each unit has its own dial to individually regulate air flow and temperature and a grey water system with heat pump has also been installed. The green roof and garden drainage ebb rainwater flows and the owner

community decided to renounce parking space for cars, opting instead for bicycle racks. The mixed construction was developed with a load bearing core for optimum thermal insulation and a suspended wooden façade; the prefabricated timber panel elements are insulated with cellulose fibres.

Rhythmic jutties characterise the façade facing the street while the south-facing garden façade is fitted with large balconies, each with folding shutters. Individual and common spaces were designed using a participatory approach and barrier-free common areas play a central role in the complex's design. Such spaces come in the form of a roof terrace, garden, a ground floor lobby, and washing station in the basement; all are barrier-free.

The complex is multigenerational, with residential units occupied by young and old as well as singles, couples, and families. A focus of the design was to facilitate mixed-generation living by ensuring that floor plans may be adapted throughout the lifecycles of the inhabitants. All flats come with ongrade showers and 88 cm wide doors; the large family apartments as well as the maisonettes have also been designed so that they can also be split into two smaller units.

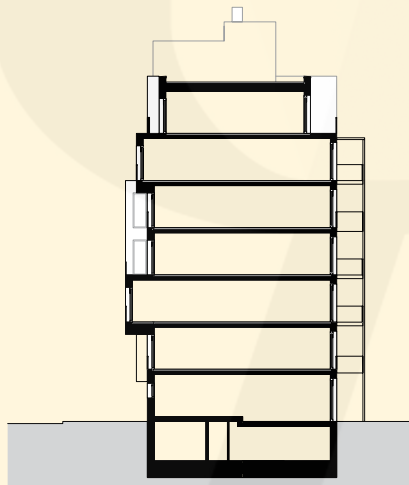

section

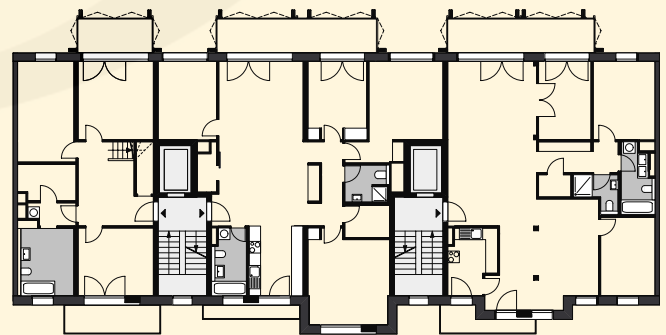



fifth floor plan

Project information

-  Certified Passive House | Apartment complex
- New build | Berlin | Germany
- Treated floor area according to PHPP: 2535 m²
- Year of construction: 2013
- Project database: ID 2979

Architects

- Deimel Oelschläger Architekten Partnerschaft
www.deo-berlin.de
-  Member of the International Passive House Association (iPHA)
-  Certified Passive House Designer

Photos

Deimel Oelschläger Architekten | Svea Pietschmann | Andrea Kroth

Build-ups | Mixed construction (timber and masonry)

- External wall (northern façade)** [U-value: 0.12 W/(m²K)]
Ventilated façade panel | 6 cm mineral wool | 27 cm wooden sandwich panel with 24 cm cellulose | oriented strand board with 5 cm mineral insulation
- External wall (southern façade)** [U-value: 0.12 W/(m²K)]
Plaster | 6 cm wood fibre insulation | 24 cm cellulose timber girder | timber board | 6 cm mineral wool | gypsum board
- Roof** [U-value: 0.11 W/(m²K)]
Reinforced concrete | 35 cm expanded polystyrene | bitumen sheeting
- Floor slab** [U-value: 0.12 W/(m²K)]
Floor screed | 10 cm impact sound insulation | reinforced concrete | 14 cm perimeter insulation | 18 cm foam glass gravel

Airtightness of building

$n_{50} = 0.27/h$

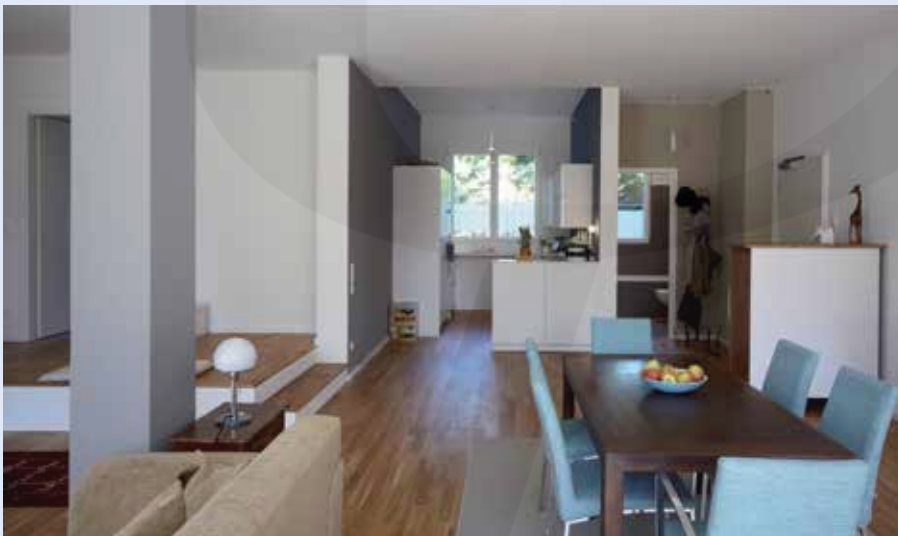

Windows

Frames [U-value, installed = 0.74 W/(m²K)]

Timber profiles with aluminium cover strip

Glazing [U-value = 0.64 W/(m²K) | g-value = 61%]

Triple glazing with low-e-coating and argon filling

Mechanical systems

Ventilation and frost protection

Heat recovery ventilation unit (semi-centralised) | ground-coupled loop heat exchanger

Heating

Combined heat and power (onsite | natural gas) | additional gas boiler as reserve

Domestic Hot Water

Combined heat and power (onsite | natural gas)

Heating demand (according to PHPP)

8 kWh/(m²a)

Heating load (according to PHPP)

9 W/m²

Cooling demand (according to PHPP)

none

Cooling load (according to PHPP)

none

Primary energy demand

(according to PHPP, including total electricity demand)

72 kWh/(m²a)



Single family homes | terraced

Belfield Homes | Philadelphia | United States

The Belfield Townhomes development was a unique opportunity to challenge the standards by which architects, urban planners, and municipal housing authorities conceptualise subsidised or social housing in the US.

The requirements for the homes were simple: design and build three much-needed homes for this struggling community that would house large, formerly homeless families, with a handicap accessible ground floor. No sustainable requirements were specified for the project, only a fixed budget and schedule: once designed and permitted, the project had to be completed in less than six months while the hard-cost construction budget for the project was limited to \$130.00 per square foot.

After reviewing the project requirements, Onion Flats, a small development, design, build collective, determined that these homes could be built for the specified budget while also becoming the first Passive House certified and Net-Zero-Energy-Capable homes in Pennsylvania. The broader goal in building this project was to demonstrate that Net-Zero-Energy-Capable

buildings can be built within the typical US public housing budgets. To achieve this goal, an efficient building system design was needed – one that was replicable, scalable, and capable of enabling radical reduction in building energy consumption.

A modular building system based on conventional framing techniques was used, making it cost-effective and easily transferrable to the building trades. The system was designed to meet Passive House requirements and can be configured to meet varying site conditions and programmatic needs. Modular construction also allows for tighter construction tolerances than traditional onsite construction while minimising waste, and cutting construction time in half.

The Belfield Townhomes were designed as a traditional row house, matching the context of the surrounding neighbourhood. The orientation of the building, following the urban grid, was challenging as it was not ideally oriented for maximum southern exposure. Shading devices on the south and west provide shade in the summer and allow for maximum heat gains in the winter. Completed in 2012, this project demonstrated that Net-Zero-Energy-Capable buildings, using Passive House as a tool, could and should be standard in the United States at virtually no cost premium.

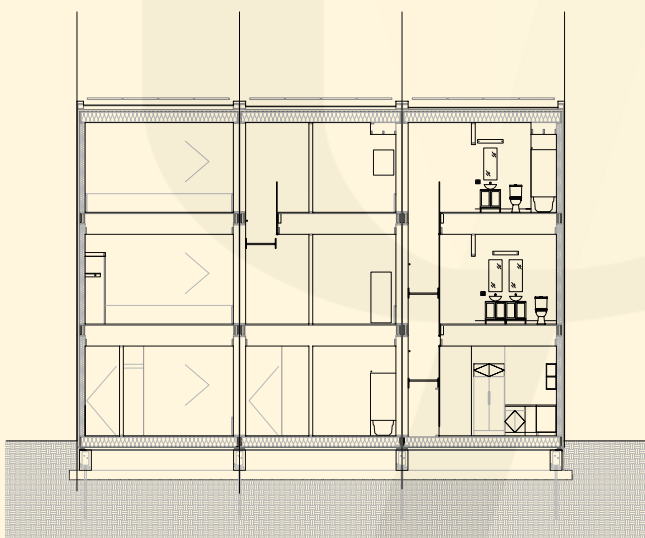

cross section

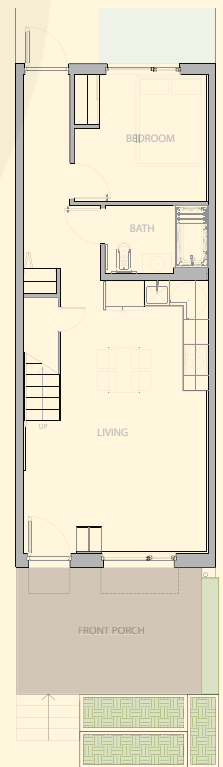

first floor plan

Project information

 Certified Passive House | Terraced housing
New build | Philadelphia | United States
Treated floor area according to PHPP: 413 m²
Year of construction: 2012
Project database: ID 3795

Architects

Plumbob LLC.
www.onionflats.com

Photos

Sam Oberter Photography

Build-ups | Timber construction

External wall [U-value: 0.17 W/(m²K)]

Gypsum board | 14 cm dense packed cellulose with studs (timber frame modular construction) | gypsum board | oriented strand board | 5.1 cm Polyiso AP foil

Roof [U-value: 0.11 W/(m²K)]

Gypsum board | 30.5 cm dense packed cellulose with studs (timber frame) | oriented strand board | 5.1 cm Polyiso AP foil | roofing

Floor slab [U-value: 0.10 W/(m²K)]

10.2 cm XPS insulation | 1.3 cm zip panel sheeting | 28.6 cm dense packed cellulose with studs (timber frame floor) | ply sub floor

Airtightness of building

$n_{50} = 0.48/h$



Windows

Frames [U-value, installed = 0.83 W/(m²K)]

Vinyl profiles | partly fixed

Glazing [U-value = 0.55 W/(m²K) | g-value = 61%]

Triple glazing with low-e-coating and argon filling

Mechanical systems

Ventilation and frost protection

Rotary wheel (heat and humidity, centralised) | rotary wheel heat exchanger

Heating

Compact heat pump unit

Domestic hot water

Heat pump

Cooling and dehumidification

Air to air split unit

Heating demand (according to PHPP)

14 kWh/(m²a)

Heating load (according to PHPP)

12 W/m²

Cooling demand (according to PHPP)

12 kWh/(m²a)

Cooling load (according to PHPP)

10 W/m²

Primary energy demand

(according to PHPP, including total electricity demand)

113 kWh/(m²a)



Single family homes | detached

Oravarinne Passive Houses | Espoo | Finland

The Oravarinne Passive Houses resulted from a pilot project started in 2010 by TA Yhtymä, a social housing company in Finland. The aim was to build three detached Passive Houses on a challenging plot. Reaching the Passive House Standard, in this case, required tailor-made products and methods that had never before been used in Finland. The planning process, however, while long and demanding, has taught all participants that extremely energy efficient construction is also possible in arctic climates.

Oravarinne, Finnish for "squirrel hill," is the name of the suburban street where the three Passive House sisters stand in Espoo, Southern Finland. The name describes the plot's properties and challenges very well, being positioned between a beautiful forest, a solid granite hill, and neighbouring houses. This typical Finnish suburban plot was challenging due to its shading situation, but well worth the effort.

The three highly insulated compact cores meet the Passive House requirements and together, with their suggestive envelopes, generate a poetic dialogue. This playful volumetric relation creates generous indoor spaces as well as semi-public / semi-private outdoor spaces that evolve into gathering points.

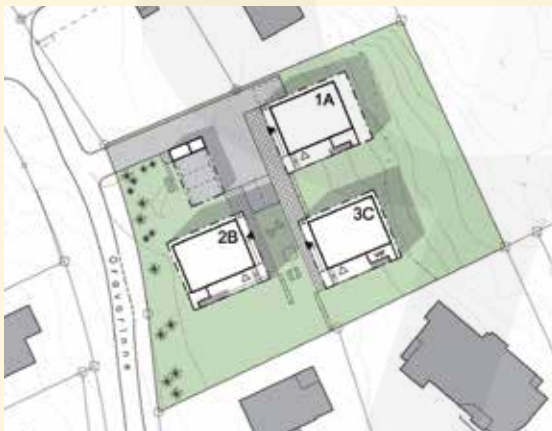

site

The compact form alone, together with the highly insulated outer walls, roofs, and floor slabs, were not enough to reach the Passive House Standard. Tailor-made, fixed windows with quadruple glazing, coming in at a U-value of 0.34 W/m²K, were necessary to meet Passive House level. With careful planning, the buildings achieved a heating load of 10 W/m².

Although this project required top performance in every aspect of energy efficiency, the building's architecture was not compromised in any way. The architectural geometry of every building consists of a compact core, surrounded by a covered terrace. Each terrace has a different depth, according to the direction it is facing. On the south side, the terraces function as structural protection from the sun during the summer while letting the sun's heat into the living spaces during the winter.

The generously sized glazed surfaces enable the beautiful surroundings to enter the rooms. An easy-going appearance as well as the cheerfulness of the houses' colours and positioning create an exemplary living environment in extreme climatic conditions. The new Passive Houses stand as proof of quality design and comfort.



plan

Project information

 Certified Passive House | Detached homes
 New build | Espoo | Finland
 Treated floor area according to PHPP: 141 m²
 Year of construction: 2013
 Project database: ID 3902

Architects

Kimmo Lylykangas Architects Ltd.
www.arklylykangas.com

Photos

Kimmo Lylykangas Architects

Build-ups | Masonry construction

External wall [U-value: 0.08 W/(m²K)]

12-15 cm reinforced concrete | 40 cm polystyrene | plaster rendering

Roof [U-value: 0.05 W/(m²K)]

Gypsum board | 12.5 cm mineral wool between wooden trusses | 63 cm blown glass wool + wooden truss girders

Floor slab [U-value: 0.09 W/(m²K)]

Reinforced concrete | 35 cm polystyrene

Airtightness of building

$n_{50} = 0.34/h$



Windows

Frames [U-value, $_{\text{installed}} = 0.57 \text{ W}/(\text{m}^2\text{K})$]

Timber profiles with aluminium cover strip | fixed and boxed windows

Glazing [U-value = $0.34 \text{ W}/(\text{m}^2\text{K})$ | g-value = 42%]

2 + 2 box windows (box window made from 2 double-glazed panes with low-e-coating and argon filling) | quadruple glazing with low-e-coating (for fixed windows)

Mechanical systems

Ventilation and frost protection

Plate heat exchanger (heat only) | subsoil heat exchanger (brine)

Heating

Brine source heat pump | floor heating

Domestic hot water

Heat pump | solar thermal collectors with 500 litres of storage

Heating demand (according to PHPP)

18 kWh/(m²a)

Heating load (according to PHPP)

10 W/m²

Cooling demand (according to PHPP)

none

Cooling load (according to PHPP)

none

Primary energy demand

(according to PHPP, including total electricity demand)

105 kWh/(m²a)



Retrofits

Tighthouse | Brooklyn, NY | United States

One of the great challenges of architecture is to accommodate the legacy of our built environment within the low energy societies of the future, without destroying the cultural heritage value they add to our cities. Retrofitting our existing homes and workplaces is therefore essential, yet it can also provide great opportunities to enhance our way of living. The Tighthouse does exactly this in exemplary style, not only creating exciting and contemporary living spaces within the historic row house context, but also delivering a double-height basement studio where the owner can practice his artistry.

The Tighthouse is the first Certified Passive House in New York City and meets the standards for new construction, surpassing EnerPHit certification for Passive House retrofits. This brownstone Passive House retrofit is at the end of a string of two-story buildings constructed in 1899 that share a tree-lined block with larger brownstones built around the same time. A truly unique Passive House retrofit of a 114 year-old brownstone, this project could serve as an important model given

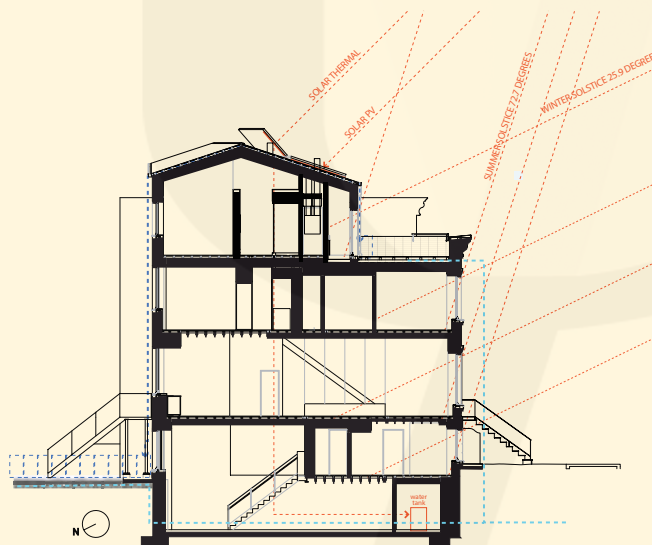

section

the large quantity of urban residences that need energy-saving retrofits.

The original character of the house is still evident in the proportions and mouldings of the street façade whilst on the top floor, folded roof planes extend upwards to enclose additional bedroom space and a private outdoor terrace. Tall ceilings, white interior walls, glazed stair partitions, and roof lights mean that daylight is reflected generously throughout the dwelling. Warmth is added by the exposed brick party walls and floor beams, giving a perfect blend of aged authenticity and crisp modernity.

Material finishes and junctions are finely crafted throughout, no doubt testament to the collaborative approach adopted by the architect and builder. Less evident in the finished building is the extent of repair work that has been undertaken to preserve the structure, a vital but often unsung skill within retrofit projects.

That all this has been achieved whilst meeting the Passive House Standard, attaining a space heating demand of only 14.6 kWh/(m²a), has made New York's first Passive House a stand-out project that will hopefully inspire many more.

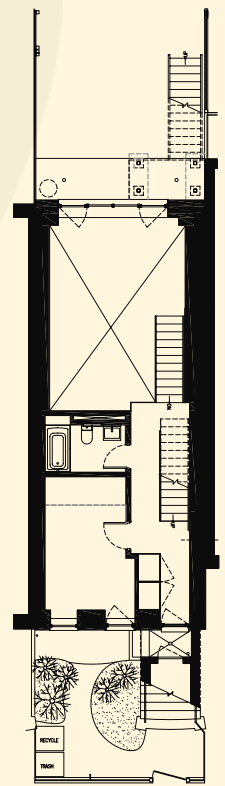

plan

Project information

 Certified Passive House | Terraced housing
 Refurbishment | Brooklyn, New York | United States
 Treated floor area according to PHPP: 195 m²
 Year of construction: 2012
 Project database: ID 2558

Architects

Fabrica718 with studio Cicetti, architect pc
www.fabrica718.com/tighthouse
 Member of the International Passive House Association (iPHA)

Photos

Hai Zhang

Build-ups | Masonry construction

External wall (revised) [U-value, weighted average: 0.19 W/(m²K)]
 Plasterboard | 1.3 cm spray foam | 10.2 cm existing brick wall | 15 cm various wall types
Roof [U-value: 0.10 W/(m²K)]
 Plasterboard | air gap | 5 x 23 cm (2 x 9 in) rafters | 3.2 cm spray foam + rafters 20.3 cm plywood | 1.9 cm Polyiso insulation + 2 x 3.5 cm wood sleepers | plywood
Floor slab [U-value: 0.51 W/(m²K)]
 Concrete slab | 5.1 cm XPS insulation

Airtightness of building

$n_{50} = 0.48/h$



Windows

Frames [U-value_{installed} = 0.83 W/(m²K)]

Vinyl profiles | partly fixed glazing | sliding doors

Glazing [U-value = 0.60 W/(m²K) | g-value = 50%]

Triple glazing with low-e-coating and argon filling

Mechanical systems

Ventilation and frost protection

Plate heat exchanger (heat only) | electric pre-heater

Heating

Air source heat pump

Domestic hot water

5 m² of solar thermal collectors + storage tank

Cooling and dehumidification

Air to air split unit

Heating demand (according to PHPP)

14 kWh/(m²a)

Heating load (according to PHPP)

13 W/m²

Cooling demand (according to PHPP)

15 kWh/(m²a)

Cooling load (according to PHPP)

15 W/m²

Primary energy demand

(according to PHPP, including total electricity demand)

104 kWh/(m²a)



TEAM GREEN
ARCHITECTS

live better

+64 3 409 0550



info@teamgreenarchitects.co.nz
www.teamgreenarchitects.co.nz

QUEENSTOWN, NEW ZEALAND



Made in Italy
Windows & Doors
Architectural Solutions

G STYLE Ltd
Point of Difference

gstyle.co.nz



LÜFTA is a manufacturer of ventilation units with heat recovery in modular and compact design for air quantities from 100-10 000 m³/h. The units are suitable for indoor and outdoor installation are used in housing constructions, in schools, kindergartens, offices buildings, etc. Passive house certified for an air flow of 600...6200 m³/h

Modern living with good healthy air!



LÜFTA GmbH, Am Schmiedanger 4,
84427 Armstorf, Germany,
Tel.: +49(0)8081/9553-0,
Fax.: +49(0)8081/9553-299
E-Mail: info@luefta.de, web: www.luefta.de



eHaus™
design for sustainable living



Everything Passive House:

- Design & Build
- Consultancy
- Air Tightness Testing
- Ventilation
- Windows



www.ehaus.co.nz



Certified Passive House Components
Quality you can rely on



www.passiv.de/komponentendatenbank/en-EN

Blower-Door-Technik
屋大夫
环境工程师

建筑密封的专家
www.haus-doktor.com
+49 4131 407997

Promoting and educating
about Passive Houses in
New Zealand



PASSIVEHOUSEINSTITUTE
NEW ZEALAND

Become a
Supporter of PHINZ

www.phinz.org.nz



Wooden Windows
 $U_w = 0,78$

The wooden window
with high performance
and environmental friendliness



INNOVATION :
Caméléwood is a trade mark,
our system is PATENTED

VARMAJ : $U_d = 0,37$
Wooden doors

Interim certificate
from
Passiv Haus Institut

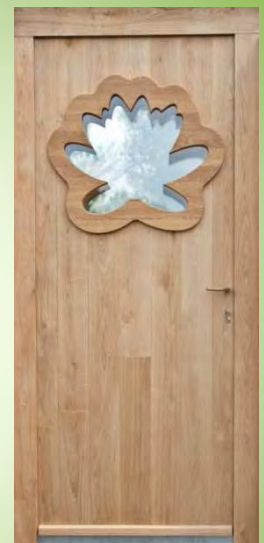

Makers of windows and doors

20 rue de la Grange

France - 25380 BELLEHERBE

contact@fenetres-franc-comtoises

www.fenetres-franc-comtoises.com

The best protection you can get

... against structural damage and mould



INTELLO®

High-performance vapour retarder/check

Maximum protection for the insulation

s_d -value 0.25 to > 10 m
(g-value 1.25 to > 50 MNs/g)
humidity variable



Detail solutions

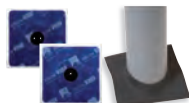

KAFLEX and ROFLEX
Airtightness grummetts for cables and pipes



INSTAABOX
Installation box for switches and sockets



CONTEGA PV
Plaster sealing tape for clearly defined transitions



REQUEST A FREE INFORMATION-BOX:

✓ **pro clima INTELLO Info-Box**

with information on building physics, systems, products, details, services, product samples, etc.

Fon +49 (0) 62 02 - 27 82.0
www.proclima.com



LAMILUX
CI-ENERGY

CI-Energy

Active energy management
with daylight systems and building controls

Save energy -

With optimum daylight intake and energy efficient, controlled flap -systems for natural ventilation and venting

Conserve energy -

With thermally separated structures and innovative glazing packages

Control energy -

With intelligently designed control and automation systems for ventilation, light guidance and solar protection

Generate energy -

With highly efficient PV systems

Rooflight domes · Continuous rooflights · Glass roof structures · SHEV control systems · Building automation systems

LAMILUX Heinrich Strunz GmbH

Zehstraße 2 · 95105 Rehau / Germany
Tel.: +49 92 83/5 95-0 · Fax: +49 92 83/5 95-2 90
information@lamilux.de · www.lamilux.de



Considering Passive House?

We are a design-led, award winning practice and are known as one of the UK's leading Passive House architects specialising in low energy buildings with a high level of comfort.

We work at all scales for public and private clients, new-build and retrofit.

Further to architectural design work, we offer PHPP, fabric moisture and thermal bridge calculations.

bere:architects
Mildmay Centre,
Woodville Road
London N16 8NA
+44 (0)20 7241 1064 www.bere.co.uk

alchemilla architects ltd
passivhaus/ecological refurbishment/energy efficiency

Alchemilla Architects Ltd is a RIBA Chartered Practice based in Rural Somerset offering a practical, modern fresh approach with a traditional twist.

T 01460 234149
M 07825 155504
E info@alchemillaarchitects.co.uk
W www.alchemillaarchitects.co.uk



PHIA

PASSIVE HOUSE international ARCHITECTS
www.phia.eu

Harbin Seoul Wassenberg Dorfen Erfurt Bozen



International Passive House Days

Visit Passive House buildings or showcase your own project!

www.passivehouse-international.org

www.passivehouse-database.org

every
november

International
PASSIVE HOUSE
Association 



THERE ARE NO COMPROMISES
CONCERNING THE WELL-BEING
WITHIN BUILDINGS.
WITH THE MULTI-COMFORT-
CONCEPT OF SAINT-GOBAIN
TOWARDS SOLUTIONS FOR:

- DESIGN FREEDOM
- ROOM CLIMATE
- QUIETNESS
- SUSTAINABILITY
- SAFETY
- TIME SAVING

I just want
more comfort

www.multi-komfort.de
www.saint-gobain.de



WINDOWS • FENSTER

FOR PASSIVE HOUSES FÜR PASSIVHÄUSER



92-PASIV
with vivaprofil

WINDOWS
FENSTER
SEMRL

Planina 189
SI - 6232 Planina
SLOVENIA

Phone: +386 51 628 505
e-mail: info@oknasemrl.eu



www.oknasemrl.eu



Accredited **Passivhaus** Design



Creating a new or renovated Passivhaus?

We can take you through each design, planning, PHPP energy assessment and construction stage of creating something special -

A stylish, comfortable building that costs very little to run.

116 Palmerston Road, Buckhurst Hill, Essex, IG9 5LQ, UK tel: +44(0)20 8504 9711
www.accreditedpassivhausdesign.com info@accreditedpassivhausdesign.com

Accredited Passivhaus Design is a trading name of The Tooley & Foster Partnership

"Certified Passive House Designer"

Intensive 10 day training course

Get to know the basics for designing and building comfortable and cost-effective Passive Houses!



PASSIVHAUS DIENSTLEISTUNG GmbH

Rheinstrasse 44-46
D-64283 Darmstadt
Tel. +49(0)6151/360 33-0
www.passivhaus-info.de
post@passivhaus-info.de

Please check our website for details of the course.



PASSIVE HOUSES IN A WIDER CONTEXT

Sweco is proud to stand behind Hedlunda preschool, which will be the world's northernmost passive house according to the international passive house definition. The passive houses at the new Minerva Secondary School and in Tavleliden in Umeå are other northerly assignments that Sweco has developed together with its clients. Learn more about our consulting services at www.swecogroup.com. Also, contact our passive house experts Thomas Greindl, +46 90 71 52 15, thomas.greindl@sweco.se or David Essinger, +46 8 522 952 11, david.essinger@sweco.se.



SWECO 
Sustainable engineering and design



The passive house of the special kind.



energy-saving building-technology

HELLMANN

varioform-haus

... the genius do-it-yourself-building-system

Hellmann varioform-haus
Master bricklayer Eckart-Rolf Hellmann
Lönsweg 13 | 29308 Winsen/Aller | Germany
Phone. + 49 5143 65 61
Fax. + 49 5143 912 892
E-Mail. e-r.hellmann@t-online.de



www.das-passivhaus.de

certified
qualified
experienced



EnerPHit^{PLUS}

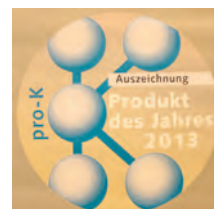

The Passive House Planning Package
... the energy balance and Passive House design tool

PHPP

Version 8 (2013) © Passive House Institute

Reliable energy balances and Passive House design made simple

With the PHPP you can:

- » Calculate energy balances
- » Plan mechanical ventilation systems
- » Determine heating and cooling loads
- » Evaluate year-round thermal comfort
- » Make use of tools for the planning of new builds and retrofits
- » Validate Passive House compliance
- » Find the entire range of Certified Passive House Components
- » Access Passive House climate data sets for locations across the globe



The PHPP is a tried and true, internationally recognised and widely used planning tool available in several languages.

PHPP

Passive House Institute
www.passivehouse.com

PHPP 8 and designPH
Planning high efficiency on a whole new level

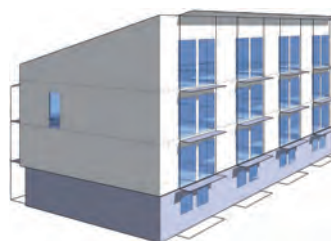

designPH

PHPP

design

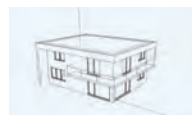

present



analyse

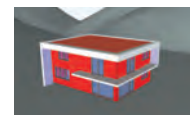

PHPP 8

Optimised for hot and humid climates with new components and climate data sets as well as additional opportunities for the calculation of renewables and enhanced compatibility, PHPP 8 is a step ahead of its predecessors.

designPH

Pair PHPP 8 with the new designPH SketchUp plugin for a entirely new planning experience. With 3-D data entry allowing for the automated or user-defined detection of the building envelope, floor area and shading, filling out the PHPP has never been easier... or more fun!

www.designph.org





GROUND BREAKING U-VALUES

FROM AS LOW AS 0.47W/m²K

Our PassiV uPVC, Aluclad and Aluminium ranges have been certified as "Passive house suitable" components by the Passive House Institute – the German based global certification authority for passive housing.

Our PassiV Range is available in uPVC, AluClad, Timber and AluP with inward opening and outward opening options available .

www.munsterjoinery.ie



MUNSTER JOINERY
THE PROFESSIONALS YOU CAN TRUST

Ballydesmond, Mallow, Co. Cork, Ireland.
T. +353 (0)64 7751313 F. +353 (0)64 7751312
E. info@munsterjoinery.ie
W. www.munsterjoinery.ie



“ Passive House: for a healthy and sustainable future indoors. ”

www.brinkclimatesystems.com

BRINK

Climate Systems

SO WELL INSULATED —
NEEDS ZERO ENERGY

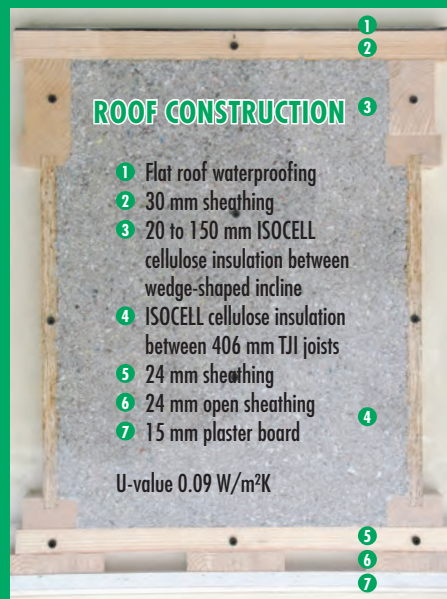

WWW.ISOCELL.AT

ISOCELL

www.isospan.at



Natureplus-Quality Seal | earthquake- and fire-safe | economical and durable | easy assembly on site | integrated heat and sound insulation

ISO SPAN
Naturbaustoffe

ARCHITECTURE | MECHANICAL DESIGN | CONSULTING
ZeroEnergy.com
 USA 617.933.9258
 First Certified PH in NYC | First Certified PH Elementary School in US





INTERNATIONAL PASSIVE HOUSE CONFERENCE

- » World's most significant gathering on energy efficiency in construction
- » Numerous sessions filled with expert presentations
- » Passive House trade fair featuring state of the art components



www.passivehouseconference.org



wood fiber insulation • intelligent airsealing systems • ductless HRV system • certified PH skylights

for essential knowledge and components
www.foursevenfive.com • 800-995-6329



The Small Planet Workshop
Passivhaus products and knowledge
 USA Toll Free: (855) for SIGA
info@smallplanetworkshop.com
www.smallplanetworkshop.com



Passive House Planning Package (PHPP) & books
shipped anywhere in the world







always around you

ENERGY STAR® • R-2000 • LEED for Homes • Passive House • Zero Energy +



To Build Tomorrow's High Performance Homes...

- Energy Efficiency Consulting
- Design Review & Energy Modeling
- Blower Door Air Tightness Testing
- Building Science Based Advice
- Training & Support

Connect With Homesol Today!
 613 278 0467  www.homesol.ca
 Visit our website, join our newsletter.





* R-2000 is an official mark of Natural Resources Canada. Used with permission. For more information on the R-2000 Standard visit www.r-2000.nrcan.gc.ca. The ENERGY STAR mark is administered in Canada by Natural Resources Canada and is used by permission.

Most Efficient Heat and Energy Recovery Ventilation Systems



As homes are becoming more tightly built, proper ventilation is increasingly critical for optimal indoor air quality. Whether for an energy-efficient home, a Passive House, or ASHRAE 62.2 requirements, Zehnder Comfosystems ensure the highest standard for quiet operation, energy efficiency and performance.

We custom design projects, offer installation support and commission our systems.

For your next project, call us for a free HRV or ERV system design quote at (888) 778-6701.

Zehnder America, Inc • 540 Portsmouth Avenue • Greenland, NH 03840
T (888) 778-6701 • www.zehnderamerica.com

always
around you

zehnder

EnerPHit

Retrofitting with
Passive House components



Retrofitting

In renovations, achieving the Passive House Standard is often not practical due to unavoidable thermal bridges in the existing structure. The Passive House Institute has thus developed the **EnerPHit Standard** for just such buildings.

EnerPHit Seal

The EnerPHit seal provides assurance that a retrofit has resulted in optimal energy performance. Through the use of Passive House components, certified EnerPHit buildings offer their users nearly all the benefits that come with Passive House while ensuring optimal cost-effectiveness in the retrofitting process.

Benefits

- Comfortable temperatures year round
- Consistently good air quality
- Protection from moisture damage
- Heating demand reductions of up to 90%
- Financial benefits from the first day on

Certification of

- Residential and non-residential buildings
- Insulation systems

www.passivehouse.com



Comfort | Affordability | Structural Longevity | Climate Protection

Passive House Institute

The institution for energy efficiency in construction



- Research and consultancy
- Dynamic building simulations
- Development and certification of Passive House building components
- Passive House building certification
- PHPP – the Passive House design tool
- International Passive House Conference
www.passivehouseconference.org
- International Passive House Association
www.passivehouse-international.org
- Passive House Designer, Consultant and Tradesperson course materials
www.passivehousedesigner.eu

www.passivehouse.com

iPHA – The International Passive House Association

International

PASSIVE HOUSE

Association



The global Passive House network for energy efficiency in construction

iPHA works to promote the Passive House Standard and foster a greater public understanding of its significance.



Encouraging the global exchange of Passive House knowledge, iPHA communicates with the media, the general public and the entire range of construction professionals.

Passive House
Comfortable | Affordable | Sustainable

Reap the benefits of iPHA membership:

- Passipedia, the wiki-based Passive House resource
- The iPHA forum, a dynamic platform for exchange
- Presentation in the iPHA member database
- Newsletters detailing Passive House developments
- Discounts on Passive House Institute services and events
- An array of expert material

Join directly, or through one of iPHA's worldwide Affiliate organisations



iPHA
Affiliate

Be part of the energy revolution

Join iPHA today!

www.passivehouse-international.org

Passive House
Award



2014



© NOON+BOUM CHO

2014 Passive House Award

A celebration of architecture, inspired by Passive House.
Over 100 examples of outstanding architecture from across
the globe entered this 2nd Passive House Award.
The winning projects are featured in this brochure.

Supported by:



Federal Ministry
for Economic Affairs
and Energy

on the basis of a decision
by the German Bundestag



International

PASSIVE HOUSE

Association



presented by